

HYDRAULIC

HOSE FITTINGS

Catalog No. H-400HF
Jul. 2023



HY-LOK CORPORATION

© 2000-2023 HY-LOK CORPORATION All rights reserved



General Informations

PART NUMBER DESIGNATIONS

H
M
C
M
-
0
2
0
2
R
/
S
T
E
L

1
2
3
4
5
6
7
8

1 Fitting Symbols

H : Hose Adapter HO : Straight Thread O-Ring Boss HS : Swivel Hose BH : Bite Type HP : Paint Shop(Option)

2 Hose Connection Seat Symbols

M : Male Flare F : Female Flare

3 Shape Symbols

A : 90° Elbow B : 45° Elbow C : Straight connector U : Union

4 End Connection Symbols

M : Male Thread F : Female Thread

5 Hose Connection Thread Size Symbols

Nom. Size	G (PF) 1/8	G (PF) 1/4	G (PF) 3/8	G (PF) 1/2	G (PF) 3/4	G (PF) 1
Identifier	01	02	03	04	06	08

6 Boss & Port Thread Size Symbols

Pipe Thread

Nom. Size	1/8	1/4	3/8	1/2	3/4	1
Identifier	01	02	03	04	06	08

Straight(unified) Thread

Nom. Size	7/16-20	1/2-20	9/16-18	3/4-16	7/8-14	1 1/16-12	1 3/16-12	1 5/16-12	1 5/8-12
Identifier	04	05	06	08	10	12	14	16	20

7 Thread Symbols

Type	Symbol	Specification
Taper Threads	R	JIS B 0203(PT), DIN2999, ISO 7/1, BS21(BSP TR.)
	N	ANSI B1.20.1(NPT)
Parallel Threads	G	JIS B 0202(PF), ISO 228/1, BS 2779(BSP PL.)
	U	American Standard Unified Screw Threads

8 Material Symbols

Materials	Carbon Steel	S. Steel 316	Brass
Identifier	STEL	S 316	BRAS

SPECIFICATIONS

- Working Pressure : Max. 315Kgf / cm²
- Temperature Range : -30℃ ~ +100℃
- Applicable Fluid : General Hydraulic Oil
- Fitting Materials : Body & Nut : Carbon Steel (KS D3526, D3752, JIS G3108, G4051)
Stainless Steel(KS D3706, JIS G4303)

* O-Ring :

Material	Temperature Range
NBR(Standard Spec.)	- 30℃ ~ +100℃
VITON	- 30℃ ~ +180℃

* O-Ring will be available only when you specify it.

HOW TO ORDER

- When placing the order with us, be sure to specify the fittings with their symbols given in the part number column on each page.
Example : HMAM - 0202R - S316
- The fitting specifications are sometimes subject to change due to continuous improvements of quality and performance
- If there is any possibility of question as to the fitting desired, particularly for special fitting configurations, it is suggested that a sketch be submitted with the fitting order.

Visual Index

High Pressure
for
210Kgf/cm²

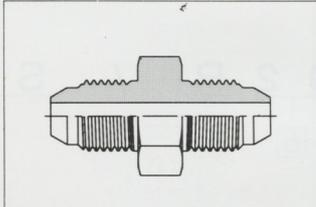
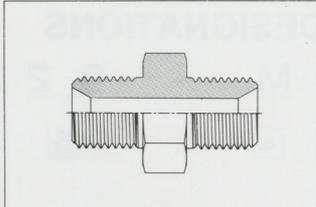
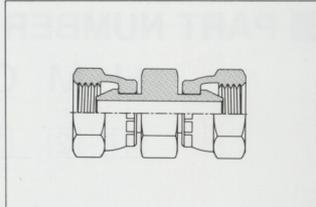
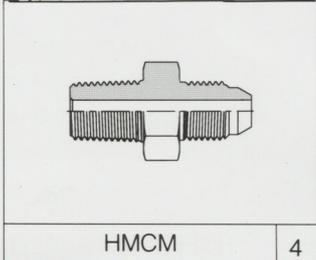
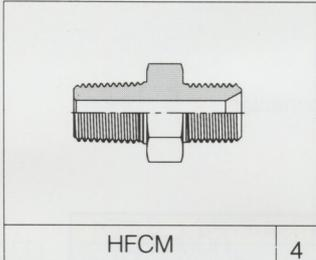
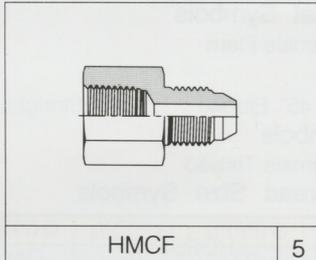
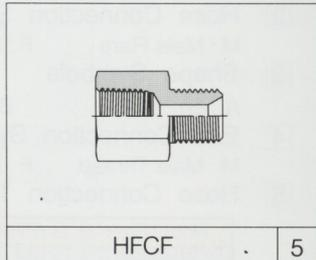
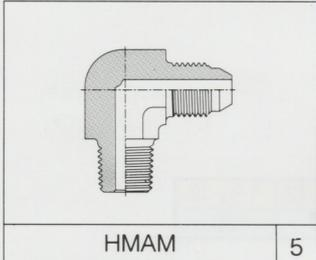
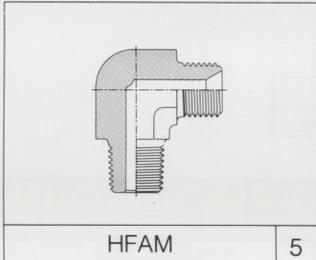
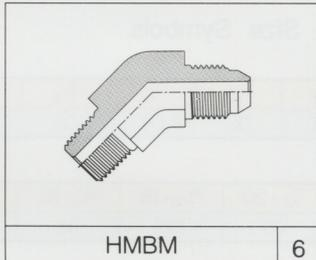
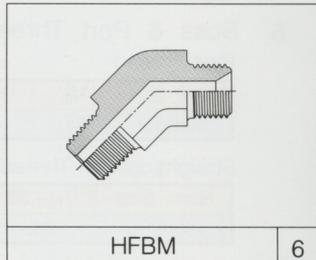
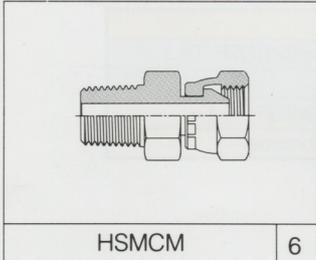
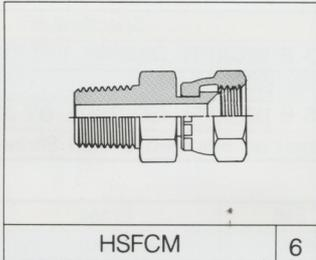
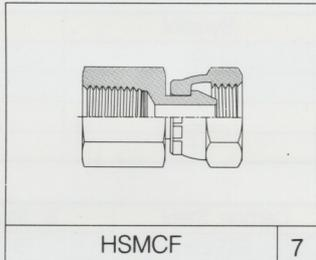
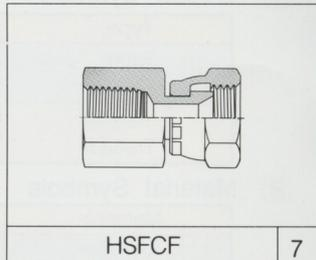
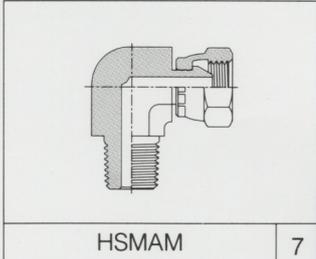
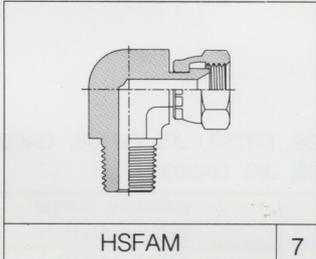
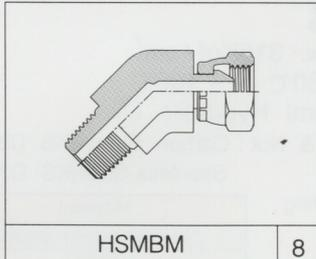
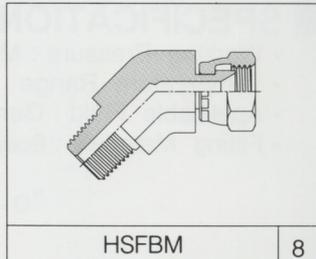
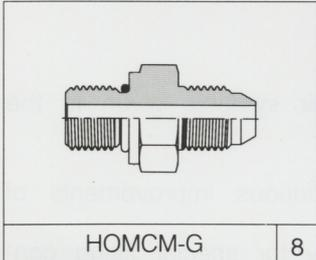
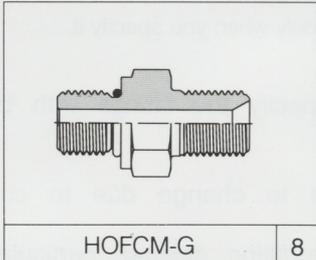
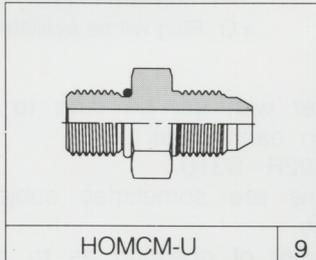
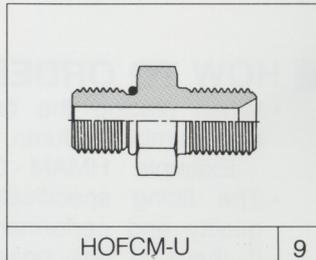
			
HMU 4	HFU 4	HSMU 4	
			
HMCM 4	HFCM 4	HMCF 5	HFCF 5
			
HMAM 5	HFAM 5	HMBM 6	HFBM 6
			
HSMCM 6	HSFCM 6	HSMCF 7	HSFCF 7
			
HSMAM 7	HSFAM 7	HSMBM 8	HSFBM 8
			
HOMCM-G 8	HOFCM-G 8	HOMCM-U 9	HOFCM-U 9

Visual Index

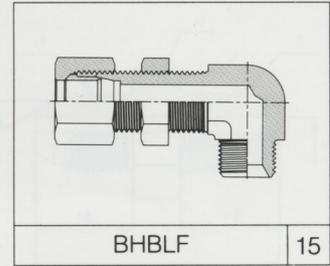
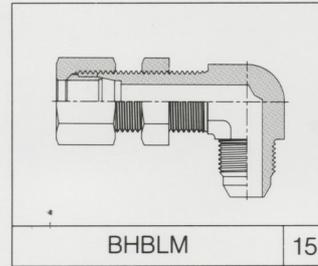
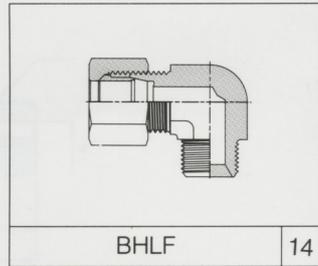
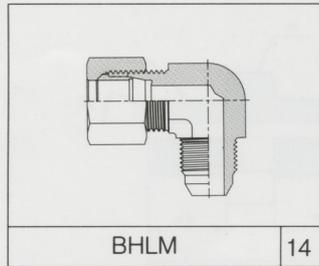
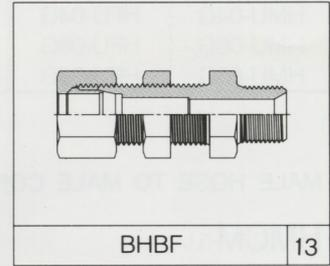
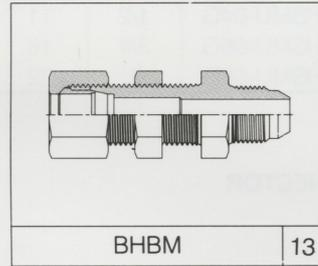
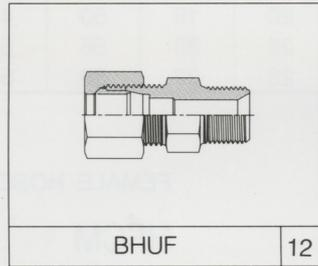
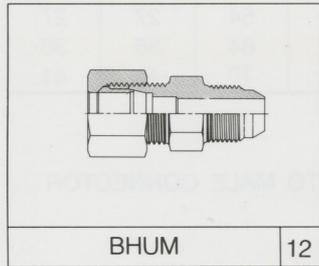
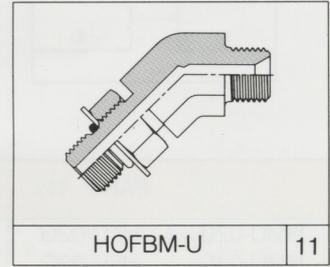
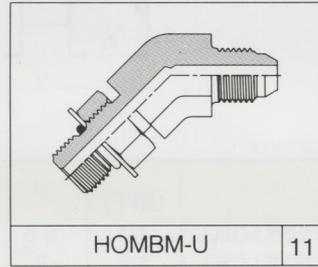
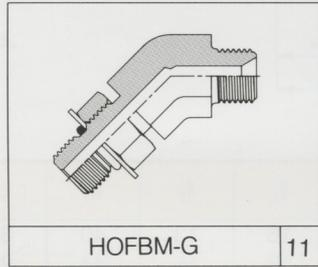
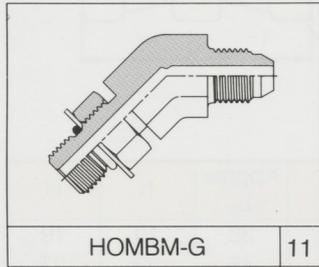
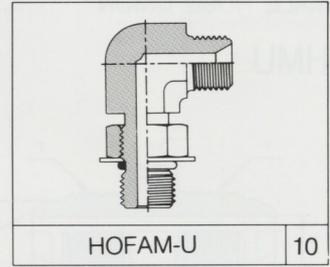
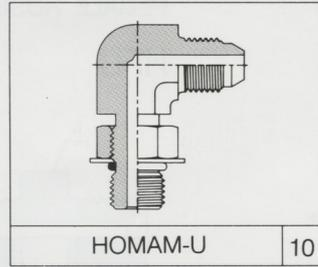
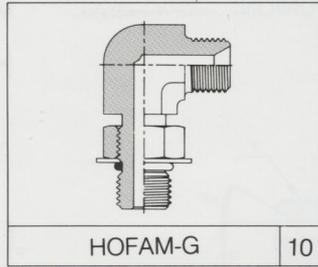
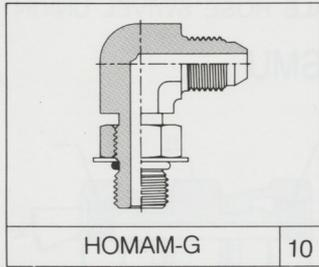

Low Pressure for 10Kgf / cm²

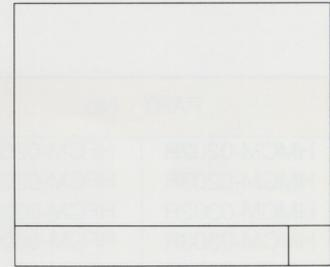
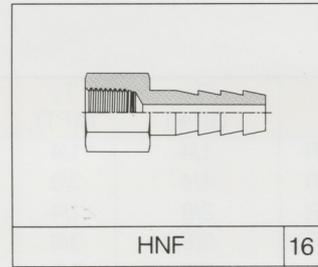
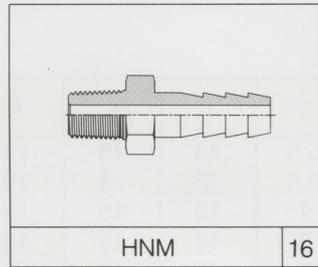

Hydraulic Hose Fittings

MALE HOSE UNION

HMU

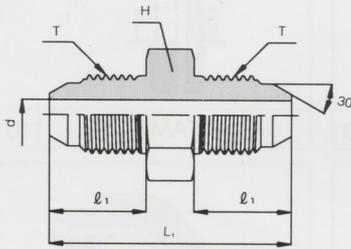

FEMALE HOSE UNION

HFU

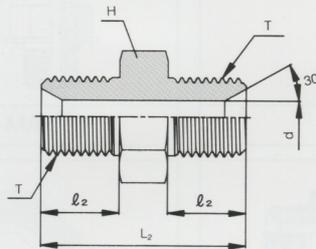

MALE HOSE SWIVEL UNION

HSMU

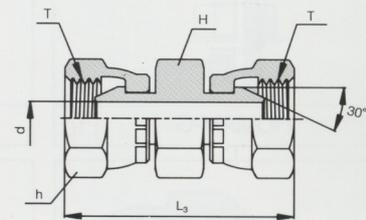

PART No.			T G(PF)	d	l ₁	l ₂	L ₁	L ₂	Approx L ₃	h	H
HMU-02G	HFU-02G	HSMU-02G	1/4	5.5	16	13	40	34	38	19	19
HMU-03G	HFU-03G	HSMU-03G	3/8	8	18	15	44	38	48	22	22
HMU-04G	HFU-04G	HSMU-04G	1/2	11	20	18	50	46	54	27	27
HMU-06G	HFU-06G	HSMU-06G	3/4	16	22	20	56	52	64	36	36
HMU-08G	HFU-08G	HSMU-08G	1	22	23	22	59	57	70	41	41

MALE HOSE TO MALE CONNECTOR

HMCM

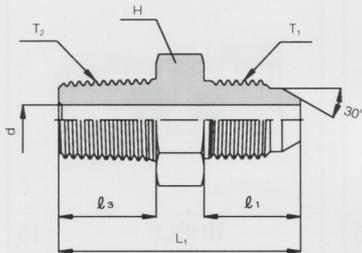

FEMALE HOSE TO MALE CONNECTOR

HFCM

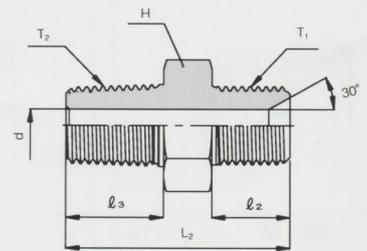

PART No.		T ₁ G(PF)	T ₂ R(PT)	d	l ₁	l ₂	l ₃	L ₁	L ₂	H
HMCM-0202R	HFCM-0202R	1/4	1/4	5.5	16	13	14	37	34	19
HMCM-0203R	HFCM-0203R	1/4	3/8	5.5	16	13	15	39	35	19
HMCM-0302R	HFCM-0302R	3/8	1/4	7	18	15	14	40	37	22
HMCM-0303R	HFCM-0303R	3/8	3/8	8	18	15	15	41	38	22
HMCM-0304R	HFCM-0304R	3/8	1/2	8	18	15	19	45	42	22
HMCM-0403R	HFCM-0403R	1/2	3/8	9	20	18	15	44	42	27
HMCM-0404R	HFCM-0404R	1/2	1/2	11	20	18	19	48	46	27
HMCM-0406R	HFCM-0406R	1/2	3/4	11	20	18	21	50	48	30
HMCM-0604R	HFCM-0604R	3/4	1/2	12	22	20	19	52	50	32
HMCM-0606R	HFCM-0606R	3/4	3/4	16	22	20	21	54	52	32
HMCM-0608R	HFCM-0608R	3/4	1	16	22	20	24	57	55	36
HMCM-0806R	HFCM-0806R	1	3/4	16	23	22	21	55	54	41
HMCM-0808R	HFCM-0808R	1	1	22	23	22	24	58	57	41

All dimensions are in millimeters. Dimensions are for reference only, subject to change.

Hydraulic Hose Fittings

MALE HOSE TO FEMALE CONNECTOR

HMCF

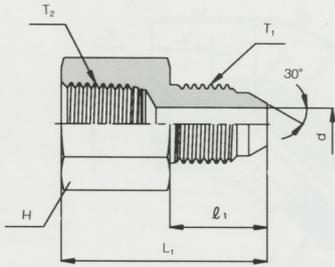

FEMALE HOSE TO FEMALE CONNECTOR

HFCF

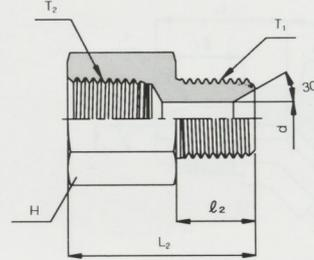

PART No.	No.	T ₁ G(PF)	T ₂ R(PT)	d	l ₁	l ₂	L ₁	L ₂	H
HMCF-0202R	HFCE-0202R	1/4	1/4	5.5	16	13	32	31	19
HMCF-0303R	HFCE-0303R	3/8	3/8	8	18	15	37	34	22
HMCF-0404R	HFCE-0404R	1/2	1/2	11	20	18	42	42	27
HMCF-0606R	HFCE-0606R	3/4	3/4	16	22	20	47	45	36
HMCF-0808R	HFCE-0808R	1	1	22	23	22	51	51	41

MALE HOSE TO MALE 90° ELBOW

HMAM

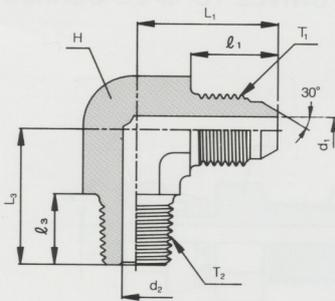

FEMALE HOSE TO MALE 90° ELBOW

HFAM

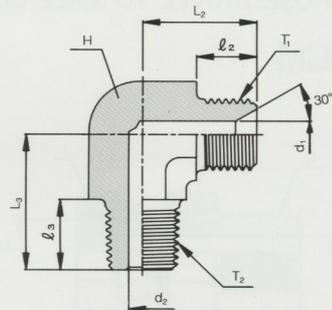

PART No.	No.	T ₁ G(PF)	T ₂ R(PT)	d ₁	d ₂	l ₁	l ₂	l ₃	L ₁	L ₂	L ₃	H
HMAM-0202R	HFAM-0202R	1/4	1/4	5.5	7	16	13	14	26	23	24	17
HMAM-0203R	HFAM-0203R	1/4	3/8	5.5	9	16	13	15	27	24	26	19
HMAM-0302R	HFAM-0302R	3/8	1/4	8	7	18	15	14	29	26	25	19
HMAM-0303R	HFAM-0303R	3/8	3/8	8	9	18	15	15	29	26	26	19
HMAM-0304R	HFAM-0304R	3/8	1/2	8	12	18	15	19	32	29	33	24
HMAM-0403R	HFAM-0403R	1/2	3/8	11	9	20	18	15	34	32	29	24
HMAM-0404R	HFAM-0404R	1/2	1/2	11	12	20	18	19	34	32	33	24
HMAM-0406R	HFAM-0406R	1/2	3/4	11	16	20	18	21	38	36	39	27
HMAM-0604R	HFAM-0604R	3/4	1/2	16	12	22	20	19	40	38	37	27
HMAM-0606R	HFAM-0606R	3/4	3/4	16	16	22	20	21	40	38	39	27
HMAM-0608R	HFAM-0608R	3/4	1	16	22	22	20	24	42	41	50	36
HMAM-0806R	HFAM-0806R	1	3/4	22	16	23	22	21	42	41	48	36
HMAM-0808R	HFAM-0808R	1	1	22	22	23	22	24	42	41	50	36

All dimensions are in millimeters. Dimensions are for reference only, subject to change.

Hydraulic Hose Fittings

MALE HOSE TO MALE 45° ELBOW

HMBM

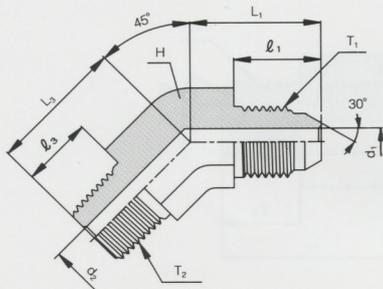

FEMALE HOSE TO MALE 45° ELBOW

HFBM

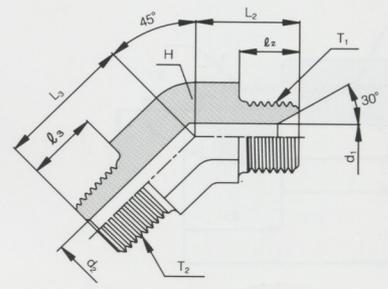

PART No.	T ₁ G(PF)	T ₂ R(PT)	d ₁	d ₂	l ₁	l ₂	l ₃	L ₁	L ₂	L ₃	H
HMBM-0202R	1/4	1/4	5.5	7	16	13	14	24	21	22	14
HMBM-0203R	1/4	3/8	5.5	9	16	13	15	24	21	23	19
HMBM-0302R	3/8	1/4	8	7	18	15	14	26	23	22	19
HMBM-0303R	3/8	3/8	8	9	18	15	15	26	23	23	19
HMBM-0304R	3/8	1/2	8	12	18	15	19	28	25	29	22
HMBM-0403R	1/2	3/8	11	9	20	18	15	30	28	25	22
HMBM-0404R	1/2	1/2	11	12	20	18	19	30	28	29	22
HMBM-0606R	3/4	3/4	16	16	22	20	21	35	33	34	27
HMBM-0808R	1	1	22	22	23	22	24	39	39	37	36

MALE HOSE SWIVEL TO MALE CONNECTOR

HSMCM

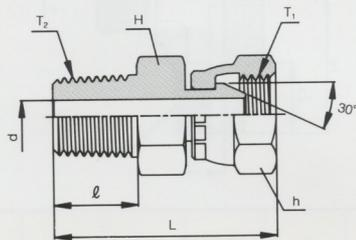

FEMALE HOSE SWIVEL TO MALE CONNECTOR

HSFCM

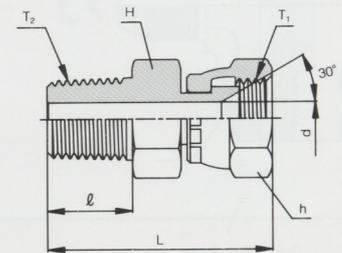

PART No.	T ₁ G(PF)	T ₂ R(PT)	d	l	Approx L	h	H
HSMCM-0202R	1/4	1/4	5.5	14	37	19	19
HSMCM-0203R	1/4	3/8	5.5	15	38	19	19
HSMCM-0302R	3/8	1/4	7	14	43	22	22
HSMCM-0303R	3/8	3/8	8	15	44	22	22
HSMCM-0304R	3/8	1/2	8	19	48	22	24
HSMCM-0403R	1/2	3/8	9	15	47	27	24
HSMCM-0404R	1/2	1/2	11	19	51	27	24
HSMCM-0606R	3/4	3/4	16	21	59	36	32
HSMCM-0808R	1	1	22	24	64	41	41

All dimensions are in millimeters. Dimensions are for reference only, subject to change.

Hydraulic Hose Fittings

MALE HOSE SWIVEL TO
FEMALE CONNECTOR
HSMCF

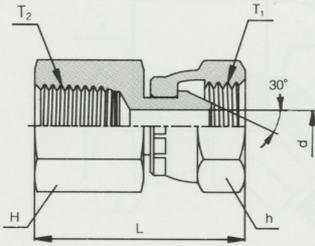

FEMALE HOSE SWIVEL TO
FEMALE CONNECTOR
HSFCF

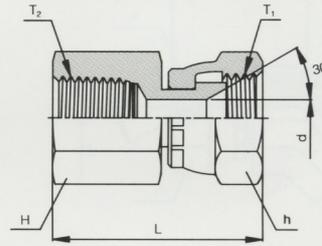

PART No.		T ₁ G(PF)	T ₂ R(PT)	d	Approx L	h	H
HSMCF-0202R	HSFCF-0202R	1/4	1/4	5.5	33	19	19
HSMCF-0203R	HSFCF-0203R	1/4	3/8	5.5	35	19	22
HSMCF-0302R	HSFCF-0302R	3/8	1/4	8	38	22	22
HSMCF-0303R	HSFCF-0303R	3/8	3/8	8	39	22	22
HSMCF-0304R	HSFCF-0304R	3/8	1/2	8	42	22	27
HSMCF-0403R	HSFCF-0403R	1/2	3/8	11	42	27	22
HSMCF-0404R	HSFCF-0404R	1/2	1/2	11	48	27	27
HSMCF-0606R	HSFCF-0606R	3/4	3/4	16	51	36	36
HSMCF-0808R	HSFCF-0808R	1	1	22	55	41	41
HSMCF-0806R	HSFCF-0806R	3/4	1	16	58	36	41

MALE HOSE SWIVEL TO MALE 90° ELBOW

HSMAM

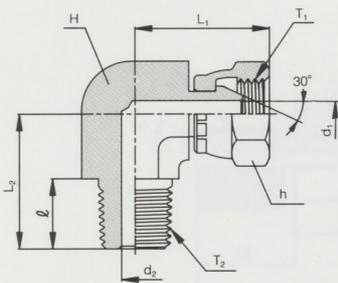

FEMALE HOSE SWIVEL TO MALE 90° ELBOW

HSFAM

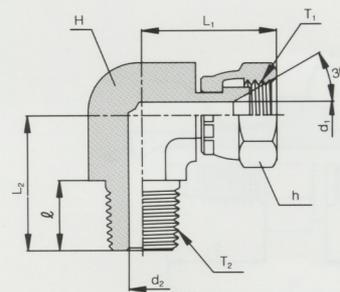

PART No.		T ₁ G(PF)	T ₂ R(PT)	d ₁	d ₂	l	Approx L ₁	L ₂	l	H
HSMAM-0202R	HSFAM-0202R	1/4	1/4	5.5	7	14	26	24	19	17
HSMAM-0203R	HSFAM-0203R	1/4	3/8	5.5	9	15	27	26	19	19
HSMAM-0302R	HSFAM-0302R	3/8	1/4	8	7	14	30	25	22	19
HSMAM-0303R	HSFAM-0303R	3/8	3/8	8	9	15	30	26	22	19
HSMAM-0304R	HSFAM-0304R	3/8	1/2	8	12	19	33	33	22	24
HSMAM-0403R	HSFAM-0403R	1/2	3/8	11	9	15	37	29	27	24
HSMAM-0404R	HSFAM-0404R	1/2	1/2	11	12	19	37	33	27	24
HSMAM-0606R	HSFAM-0606R	3/4	3/4	16	16	21	45	39	36	30
HSMAM-0808R	HSFAM-0808R	1	1	22	22	24	51	45	41	36

All dimensions are in millimeters. Dimensions are for reference only, subject to change.

Hydraulic Hose Fittings

MALE HOSE SWIVEL TO
MALE 45° ELBOW
HSMBM

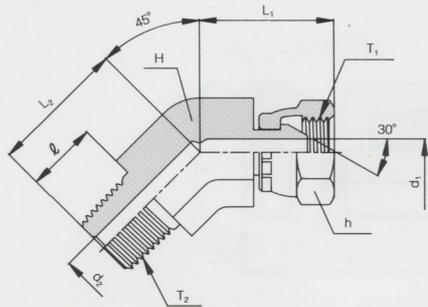

FEMALE HOSE SWIVEL TO
MALE 45° ELBOW
HSFBM

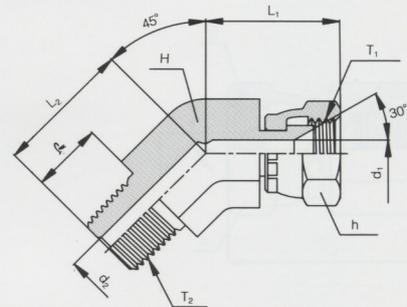

PART No.	T ₁ G(PF)	T ₂ R(PT)	d ₁	d ₂	l	Approx L ₁	L ₂	h	H
HSMBM-0202R	1/4	1/4	5.5	7	14	23	21	19	17
HSMBM-0203R	1/4	3/8	5.5	9	15	24	23	19	19
HSMBM-0302R	3/8	1/4	8	7	14	27	22	22	19
HSMBM-0303R	3/8	3/8	8	9	15	27	23	22	19
HSMBM-0304R	3/8	1/2	8	12	19	29	29	22	24
HSMBM-0403R	1/2	3/8	11	9	15	33	25	27	24
HSMBM-0404R	1/2	1/2	11	12	19	33	29	27	24
HSMBM-0606R	3/4	3/4	16	16	21	40	34	36	30
HSMBM-0808R	1	1	22	22	24	44	41	41	36

MALE HOSE TO STRAIGHT PIPE THREAD
O - RING BOSS CONNECTOR
HOMCM - G

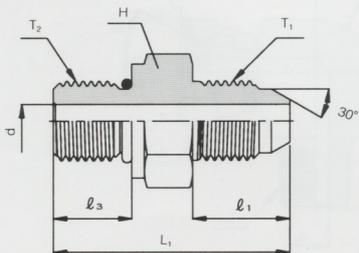

FEMALE HOSE TO STRAIGHT PIPE THREAD
O - RING BOSS CONNECTOR
HOFM - G

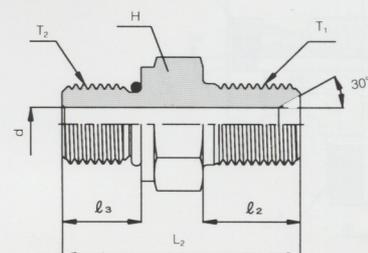

PART No.	T ₁ G(PF)	T ₂ G(PF)	d	l ₁	l ₂	l ₃	L ₁	L ₂	H
HOMCM-0202G	1/4	1/4	5.5	16	13	12	35	32	19
HOMCM-0203G	1/4	3/8	5.5	16	13	12	35	32	22
HOMCM-0302G	3/8	1/4	5.5	18	15	12	37	34	19
HOMCM-0303G	3/8	3/8	8	18	15	12	37	34	22
HOMCM-0304G	3/8	1/2	8	18	15	14	41	38	27
HOMCM-0403G	1/2	3/8	8	20	18	12	41	39	22
HOMCM-0404G	1/2	1/2	11	20	18	14	43	41	27
HOMCM-0606G	3/4	3/4	16	22	20	16	48	46	36
HOMCM-0808G	1	1	22	23	22	18	55	53	41

All dimensions are in millimeters. Dimensions are for reference only, subject to change.

Hydraulic Hose Fittings

MALE HOSE TO SAE / MS STRAIGHT THREAD
O - RING BOSS CONNECTOR
HOMCM - U

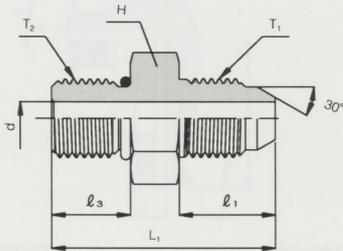

FEMALE HOSE TO SAE / MS STRAIGHT THREAD
O - RING BOSS CONNECTOR
HOFCM - U

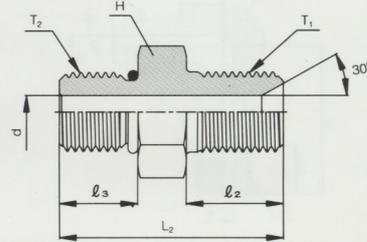

PART No.	T ₁ G(PF)	T ₂ R(UNF)	d	l ₁	l ₂	l ₃	L ₁	L ₂	H	
HOMCM-0204U	HOFCM-0204U	1/4	7/16 - 20	4	16	13	10	33	30	14.2
HOMCM-0205U	HOFCM-0205U	1/4	1/2 - 20	5.5	16	13	11	34	31	15.8
HOMCM-0306U	HOFCM-0306U	3/8	9/16 - 18	8	18	15	14	39	36	17.4
HOMCM-0308U	HOFCM-0308U	3/8	3/4 - 16	8	18	15	14	39	36	22.2
HOMCM-0310U	HOFCM-0310U	3/8	7/8 - 14	8	18	15	14	40	37	25.4
HOMCM-0408U	HOFCM-0408U	1/2	3/4 - 16	10	20	18	14	42	40	22.2
HOMCM-0410U	HOFCM-0410U	1/2	7/8 - 14	11	20	18	14	42	40	25.4
HOMCM-0412U	HOFCM-0412U	1/2	1-1/16 - 12	11	20	18	17	46	44	32
HOMCM-0612U	HOFCM-0612U	3/4	1-1/16 - 12	16	22	20	17	46	44	32
HOMCM-0616U	HOFCM-0616U	3/4	1-5/16 - 12	16	22	20	18	50	48	38
HOMCM-0816U	HOFCM-0816U	1	1-5/16 - 12	22	23	22	18	53	52	38

INSTALLATION INSTRUCTIONS

STRAIGHT THREAD O - RING BOSS FITTINGS

- O - Ring has to be lubricated with slight coat of system fluid or its compatible oil.
- Insert it in the groove up to the face of the metal back - up washer that is pre - installed at the extreme end of the same groove.
- Screw the fitting into boss until the face of boss reaches up to the metal back - up washer.

- Unscrew the fitting to the direction of incoming hose assembly within maximum one full turn.
- Tighten the locknut by holding fitting in desired position with wrench until the washer is fully faced with the face of the boss.

PRECAUTION TO PREVENT LEAK.

Make sure of O-Ring being not pinched and back - up washer seating flat.

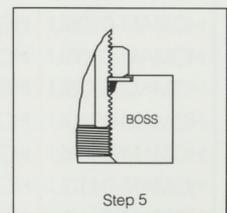
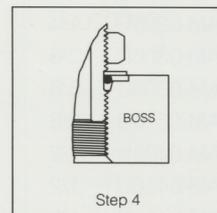
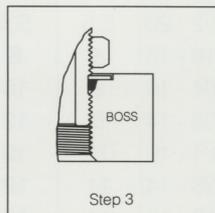
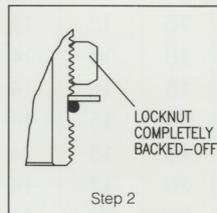
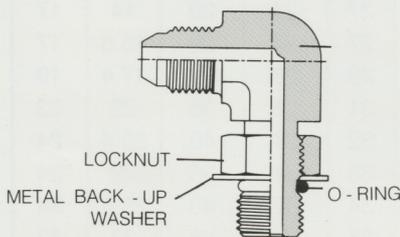

All dimensions are in millimeters. Dimensions are for reference only, subject to change.

Hydraulic Hose Fittings

MALE HOSE TO STRAIGHT PIPE THREAD
O - RING BOSS 90° ELBOW
HOMAM - G

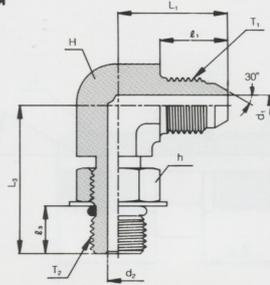

FEMALE HOSE TO STRAIGHT PIPE THREAD
O - RING BOSS 90° ELBOW
HOFAM - G

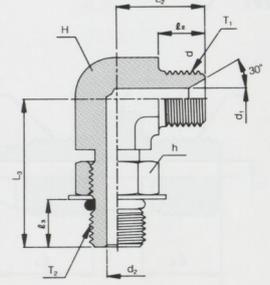

PART No.	T ₁ G(PF)	T ₂ G(PF)	d ₁	d ₂	ℓ ₁	ℓ ₂	ℓ ₃	L ₁	L ₂	L ₃	h	H	
HOMAM-0202G	HOFAM-0202G	1/4	1/4	5.5	5.5	16	13	11	27	24	36	19	17
HOMAM-0203G	HOFAM-0203G	1/4	3/8	5.5	8	16	13	13	27	24	37	22	19
HOMAM-0302G	HOFAM-0302G	3/8	1/4	8	5.5	18	15	11	29	26	36	19	19
HOMAM-0303G	HOFAM-0303G	3/8	3/8	8	8	18	15	13	29	26	37	22	19
HOMAM-0304G	HOFAM-0304G	3/8	1/2	8	11	18	15	15	32	26	46	27	24
HOMAM-0403G	HOFAM-0403G	1/2	3/8	11	8	20	18	11	34	32	40	22	24
HOMAM-0404G	HOFAM-0404G	1/2	1/2	11	11	20	18	15	34	32	46	27	24
HOMAM-0406G	HOFAM-0406G	1/2	3/4	11	16	20	18	16	38	36	52	36	32
HOMAM-0604G	HOFAM-0604G	3/4	1/2	16	11	22	20	15	38	38	50	27	32
HOMAM-0606G	HOFAM-0606G	3/4	3/4	16	16	22	20	16	38	38	52	36	32
HOMAM-0808G	HOFAM-0808G	1	1	22	22	23	22	18	42	42	62	41	36

MALE HOSE TO SAE / MS STRAIGHT THREAD
O - RING BOSS 90° ELBOW
HOMAM - U

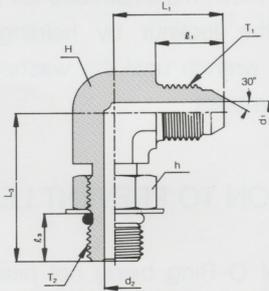

FEMALE HOSE TO SAE / MS STRAIGHT THREAD
O - RING BOSS 90° ELBOW
HOFAM - U

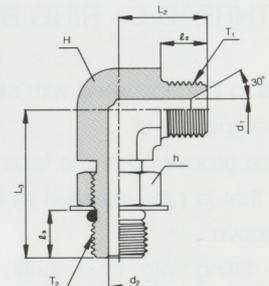

PART No.	T ₁ G(PF)	T ₂ (UNF)	d ₁	d ₂	ℓ ₁	ℓ ₂	ℓ ₃	L ₁	L ₂	L ₃	h	H	
HOMAM-0204U	HOFAM-0204U	1/4	7/16 - 20	5.5	4	16	13	10	27	24	29	14	17
HOMAM-0205U	HOFAM-0205U	1/4	1/2 - 20	5.5	5.5	16	13	11	27	24	29	15.8	17
HOMAM-0306U	HOFAM-0306U	3/8	9/16 - 18	8	8	18	15	14	29	26	31	17.4	19
HOMAM-0308U	HOFAM-0308U	3/8	3/4 - 16	8	10	18	15	14	31	28	36	22	22
HOMAM-0310U	HOFAM-0310U	3/8	7/8 - 14	8	12	18	15	14	32	29	40	25.4	24
HOMAM-0408U	HOFAM-0408U	1/2	3/4 - 16	11	10	20	18	14	33	31	36	22	24
HOMAM-0410U	HOFAM-0410U	1/2	7/8 - 14	11	12	20	18	14	34	32	40	25.4	24
HOMAM-0412U	HOFAM-0412U	1/2	1-1/16 - 12	11	16	20	18	17	38	36	48	32	32
HOMAM-0612U	HOFAM-0612U	3/4	1-1/16 - 12	16	16	22	20	17	40	38	48	32	32
HOMAM-0616U	HOFAM-0616U	3/4	1-5/16 - 12	16	22	22	20	18	42	38	51	38	36
HOMAM-0816U	HOFAM-0816U	1	1-5/16 - 12	22	22	23	22	18	42	42	51	38	36

All dimensions are in millimeters. Dimensions are for reference only, subject to change.

Hydraulic Hose Fittings

MALE HOSE TO STRAIGHT PIPE THREAD
O - RING BOSS 45° ELBOW
HOMBM - G

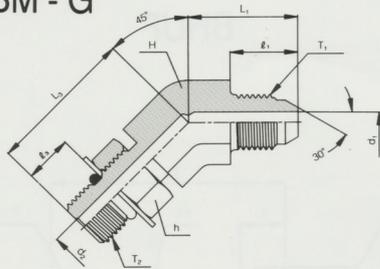

FEMALE HOSE TO STRAIGHT PIPE THREAD
O - RING BOSS 45° ELBOW
HOFBM - G

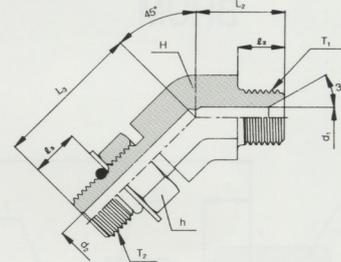

PART No.	T ₁ G(PF)	T ₂ G(PF)	d ₁	d ₂	l ₁	l ₂	l ₃	L ₁	L ₂	L ₃	h	H	
HOMBM-0202G	HOFBM-0202G	1/4	1/4	5.5	5.5	16	13	11	24	21	33	19	19
HOMBM-0203G	HOFBM-0203G	1/4	3/8	5.5	8	16	13	13	24	21	34	22	19
HOMBM-0302G	HOFBM-0302G	3/8	1/4	8	5.5	18	15	11	26	23	33	19	19
HOMBM-0303G	HOFBM-0303G	3/8	3/8	8	8	18	15	13	26	23	34	22	19
HOMBM-0304G	HOFBM-0304G	3/8	1/2	8	11	18	15	15	28	25	42	27	24
HOMBM-0403G	HOFBM-0403G	1/2	3/8	11	8	20	18	11	30	28	36	22	24
HOMBM-0404G	HOFBM-0404G	1/2	1/2	11	11	20	18	15	30	28	42	27	24
HOMBM-0406G	HOFBM-0406G	1/2	3/4	11	16	20	18	16	33	31	47	36	27
HOMBM-0604G	HOFBM-0604G	3/4	1/2	16	11	22	20	15	35	33	45	27	27
HOMBM-0606G	HOFBM-0606G	3/4	3/4	16	16	22	20	16	35	33	47	36	27
HOMBM-0808G	HOFBM-0808G	1	1	22	22	23	22	18	40	39	58	41	

MALE HOSE TO SAE / MS STRAIGHT THREAD
O - RING BOSS 45° ELBOW
HOMBM - U

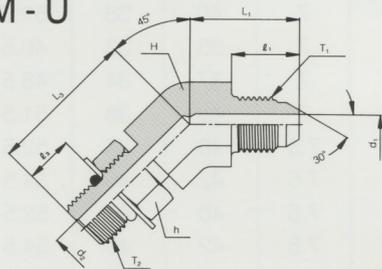

FEMALE HOSE TO SAE / MS STRAIGHT THREAD
O - RING BOSS 45° ELBOW
HOFBM - U

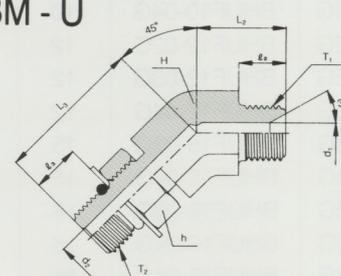

PART No.	T ₁ G(PF)	T ₂ (UNF)	d ₁	d ₂	l ₁	l ₂	l ₃	L ₁	L ₂	L ₃	h	H	
HOMBM-0204U	HOFBM-0204U	1/4	7/16 - 20	5.5	4	16	13	10	24	21	26	14	17
HOMBM-0205U	HOFBM-0205U	1/4	1/2 - 20	5.5	5.5	16	13	11	24	21	26	15.8	17
HOMBM-0306U	HOFBM-0306U	3/8	9/16 - 18	8	8	18	15	14	26	23	28	17.4	19
HOMBM-0308U	HOFBM-0308U	3/8	3/4 - 16	8	10	18	15	14	28	25	33	22	22
HOMBM-0310U	HOFBM-0310U	3/8	7/8 - 14	8	12	18	15	14	28	25	36	25.4	24
HOMBM-0408U	HOFBM-0408U	1/2	3/4 - 16	11	10	20	18	14	30	28	33	22	22
HOMBM-0410U	HOFBM-0410U	1/2	7/8 - 14	11	12	20	18	14	30	28	36	25.4	24
HOMBM-0412U	HOFBM-0412U	1/2	1-1/16 - 12	11	16	20	18	17	33	31	43	32	30
HOMBM-0612U	HOFBM-0612U	3/4	1-1/16 - 12	16	16	22	20	17	35	33	43	32	30
HOMBM-0616U	HOFBM-0616U	3/4	1-5/16 - 12	16	22	22	20	18	39	37	47	38	36
HOMBM-0816U	HOFBM-0816U	1	1-5/16 - 12	22	22	23	22	18	40	39	47	38	36

All dimensions are in millimeters. Dimensions are for reference only, subject to change.

Hydraulic Hose Fittings

BITE TO MALE HOSE UNION

BHUM

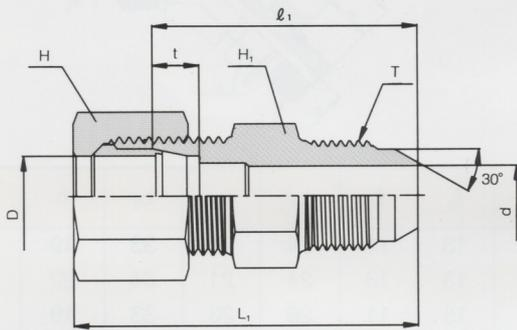

BITE TO FEMALE HOSE UNION

BHUF

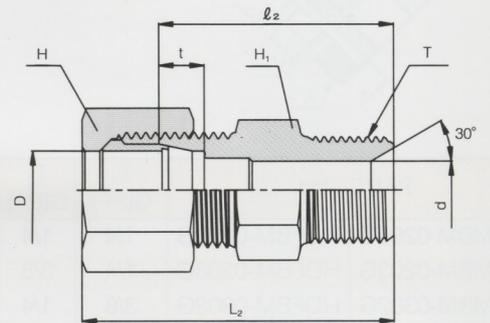

PART No.	Tube O · D	T G(PF)	d	H ₁	H	t	ℓ ₁	ℓ ₂	Approx L ₁	Approx L ₂	
BHUM08-02G	BHUF08-02G	8	1/4	6	17	17	7	35	33	45.5	43.5
BHUM08-03G	BHUF08-03G	8	3/8	6	19	17	7	37	34	47.5	44.5
BHUM10-02G	BHUF10-02G	10	1/4	6	17	19	7	35	33	46.5	44.5
BHUM10-03G	BHUF10-03G	10	3/8	8	19	19	7	37	34	48.5	45.5
BHUM10-04G	BHUF10-04G	10	1/2	8	22	19	7	40	38	51.5	49.5
BHUM12-02G	BHUF12-02G	12	1/4	6	19	22	7	35	33	46.5	44.5
BHUM12-03G	BHUF12-03G	12	3/8	9	19	22	7	37	34	48.5	45.5
BHUM12-04G	BHUF12-04G	12	1/2	10	22	22	7	40	38	51.5	49.5
BHUM15-03G	BHUF15-03G	15	3/8	9	24	27	7.5	40	37	52.5	49.5
BHUM15-04G	BHUF15-04G	15	1/2	12	24	27	7.5	42	40	54.5	52.5
BHUM16-03G	BHUF16-03G	16	3/8	9	27	30	7.5	40	37	52.5	49.5
BHUM16-04G	BHUF16-04G	16	1/2	12	27	30	7.5	42	40	54.5	52.5
BHUM18-04G	BHUF18-04G	18	1/2	12	27	32	8	42	40	54.5	52.5
BHUM20-06G	BHUF20-06G	20	3/4	16	30	36	8	46	43	58.5	55.5
BHUM22-04G	BHUF22-04G	22	1/2	12	32	36	9	44	42	56.5	54.5
BHUM22-06G	BHUF22-06G	22	3/4	16	32	36	9	46	43	58.5	55.5
BHUM25-06G	BHUF25-06G	25	3/4	16	36	41	10	47	44	60.5	57.5
BHUM25-08G	BHUF25-08G	25	1	20	36	41	10	49	46	62.5	59.5
BHUM28-06G	BHUF28-06G	28	3/4	16	41	46	10	49	46	63	60
BHUM28-08G	BHUF28-08G	28	1	22	41	46	10	51	48	65	62
BHUM30-06G	BHUF30-06G	30	3/4	16	41	46	10	49	46	63.5	60.5
BHUM30-08G	BHUF30-08G	30	1	22	41	46	10	51	48	65.5	62.5
BHUM32-08G	BHUF32-08G	32	1	22	46	50	11	52	49	66.5	63.5
BHUM32-10G	BHUF32-10G	32	1 1/4	28	46	50	11	56	55	70.5	69.5

All dimensions are in millimeters. Dimensions are for reference only, subject to change.

Hydraulic Hose Fittings

BITE TO MALE HOSE BULKHEAD UNION

BITE TO FEMALE HOSE BULKHEAD UNION

BHBM

BHBF

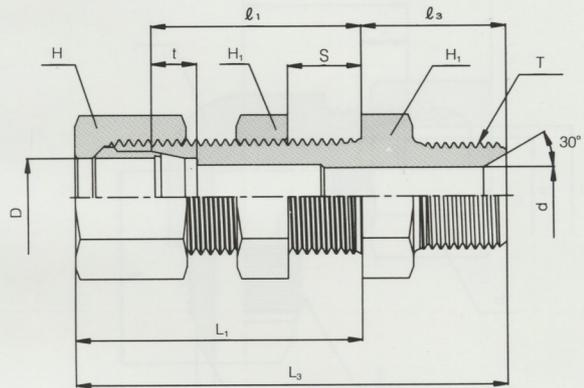
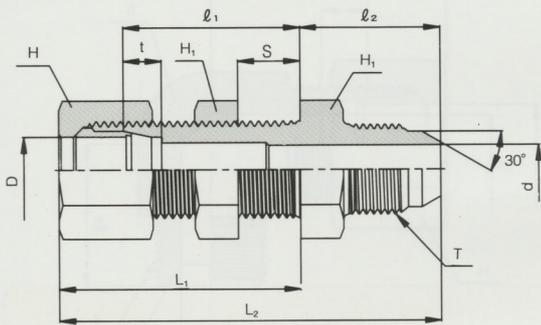

PART No.	Tube O.D	T G(PF)	d	H ₁	H	t	l ₁	l ₂	l ₃	Approx L ₁	Approx L ₂	Approx L ₃	Panel Hole Drill size	Max Panel thickness S	
BHBM08-02G	BHBF08-02G	8	1/4	6	19	17	7	32	23	21	42.5	65.5	63.5	14.5	13
BHBM08-03G	BHBF08-03G	8	3/8	6	19	17	7	32	25	22	42.5	67.5	64.5	14.5	13
BHBM10-02G	BHBF10-02G	10	1/4	6	22	19	7	32	24	22	43.5	67.5	65.5	16.5	13
BHBM10-03G	BHBF10-03G	10	3/8	8	22	19	7	32	26	23	43.5	69.5	66.5	16.5	13
BHBM10-04G	BHBF10-04G	10	1/2	8	22	19	7	32	28	26	43.5	71.5	69.5	16.5	13
BHBM12-02G	BHBF12-02G	12	1/4	6	24	22	7	32	24	22	43.5	67.5	65.5	18.5	13
BHBM12-03G	BHBF12-03G	12	3/8	9	24	22	7	32	26	23	43.5	69.5	66.5	18.5	13
BHBM12-04G	BHBF12-04G	12	1/2	10	24	22	7	32	28	26	43.5	71.5	69.5	18.5	13
BHBM15-03G	BHBF15-03G	15	3/8	9	27	27	7.5	37	26	23	49.5	75.5	72.5	22.5	15
BHBM15-04G	BHBF15-04G	15	1/2	12	27	27	7.5	37	28	26	49.5	77.5	75.5	22.5	15
BHBM16-03G	BHBF16-03G	16	3/8	9	30	30	7.5	37	28	25	49.5	77.5	74.5	24.5	15
BHBM16-04G	BHBF16-04G	16	1/2	12	30	30	7.5	37	30	28	49.5	79.5	77.5	24.5	15
BHBM18-04G	BHBF18-04G	18	1/2	12	32	32	8	39	30	28	51.5	81.5	79.5	26.5	15
BHBM20-06G	BHBF20-06G	20	3/4	16	32	36	8	39	32	29	51.5	83.5	80.5	28.5	15
BHBM22-04G	BHBF22-04G	22	1/2	12	36	36	9	39	31	29	51.5	82.5	80.5	30.5	15
BHBM22-06G	BHBF22-06G	22	3/4	16	36	36	9	39	33	30	51.5	84.5	81.5	30.5	15
BHBM25-06G	BHBF25-06G	25	3/4	16	41	41	10	39	33	30	52.5	87.5	82.5	35.5	15
BHBM25-08G	BHBF25-08G	25	1	20	41	41	10	39	35	32	52.5	89.5	84.5	35.5	15
BHBM28-06G	BHBF28-06G	28	3/4	16	46	46	10	41	34	31	55	89	86	38.5	15
BHBM28-08G	BHBF28-08G	28	1	22	46	46	10	41	36	33	55	91	88	38.5	15
BHBM30-06G	BHBF30-06G	30	3/4	16	46	46	10	41	34	31	55.5	89.5	86.5	40.5	15
BHBM30-08G	BHBF30-08G	30	1	22	46	46	10	41	36	33	55.5	91.5	88.5	40.5	15
BHBM32-08G	BHBF32-08G	32	1	22	50	50	11	43	38	35	57.5	95.5	92.5	42.5	15
BHBM32-10G	BHBF32-10G	32	1 1/4	28	50	50	11	43	42	41	57.5	99.5	98.5	42.5	15

All dimensions are in millimeters. Dimensions are for reference only, subject to change.

Hydraulic Hose Fittings

BITE TO MALE HOSE ELBOW

BHLM

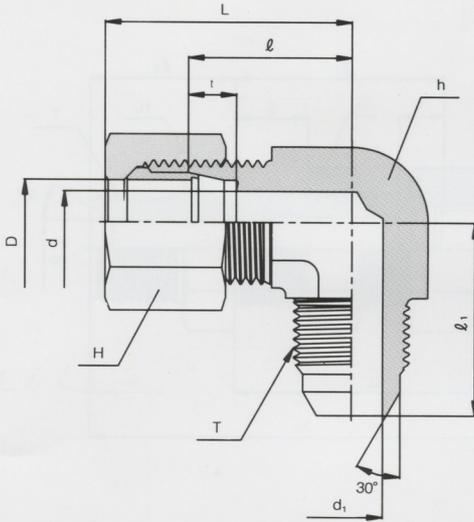

BITE TO FEMALE HOSE ELBOW

BHLF

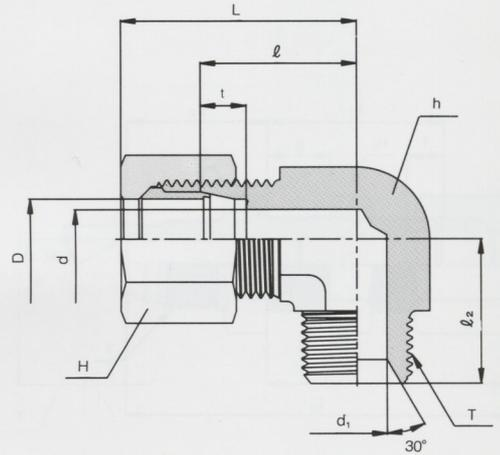

PART No.	Tube O · D	T G(PF)	d	d ₁	h	H	t	l	l ₁	l ₂	Approx L	
BHLM08-02G	BHLF08-02G	8	1/4	6	6	17	17	7	23	25	25	33.5
BHLM08-03G	BHLF08-03G	8	3/8	6	9	19	17	7	24	28	27	34.5
BHLM10-02G	BHLF10-02G	10	1/4	8	6	19	19	7	24	28	26	35.5
BHLM10-03G	BHLF10-03G	10	3/8	8	9	19	19	7	24	28	27	35.5
BHLM10-04G	BHLF10-04G	10	1/2	8	12	24	19	7	29	34	33	40.5
BHLM12-02G	BHLF12-02G	12	1/4	10	6	19	22	7	24	28	26	35.5
BHLM12-03G	BHLF12-03G	12	3/8	10	9	19	22	7	24	28	27	35.5
BHLM12-04G	BHLF12-04G	12	1/2	10	12	24	22	7	29	34	33	40.5
BHLM15-03G	BHLF15-03G	15	3/8	12	9	24	27	7.5	29	33	30	41.5
BHLM15-04G	BHLF15-04G	15	1/2	12	12	24	27	7.5	29	34	33	41.5
BHLM16-03G	BHLF16-03G	16	3/8	13	9	27	30	7.5	32	36	33	44.5
BHLM16-04G	BHLF16-04G	16	1/2	13	12	27	30	7.5	32	38	36	44.5
BHLM18-04G	BHLF18-04G	18	1/2	14	12	27	32	8	32	38	36	44.5
BHLM20-06G	BHLF20-06G	20	3/4	17	16	30	36	8	33	41	38	45.5
BHLM22-04G	BHLF22-04G	22	1/2	18	12	32	36	9	34	40	38	46.5
BHLM22-06G	BHLF22-06G	22	3/4	18	16	32	36	9	34	42	39	46.5
BHLM25-06G	BHLF25-06G	25	3/4	20	16	36	41	10	36	44	41	49.5
BHLM25-08G	BHLF25-08G	25	1	20	20	36	41	10	36	46	43	49.5
BHLM28-06G	BHLF28-06G	28	3/4	22	16	41	46	10	41	47	44	55
BHLM28-08G	BHLF28-08G	28	1	22	22	41	46	10	41	49	46	55
BHLM30-06G	BHLF30-06G	30	3/4	25	16	41	46	10	41	47	44	55.5
BHLM30-08G	BHLF30-08G	30	1	25	22	41	46	10	41	49	46	55.5
BHLM32-08G	BHLF32-08G	32	1	26	22	46	50	11	46	54	51	60.5
BHLM32-10G	BHLF32-10G	32	1 1/4	26	28	46	50	11	46	56	57	60.5

All dimensions are in millimeters. Dimensions are for reference only, subject to change.

Hydraulic Hose Fittings

BITE TO MALE HOSE BULKHEAD ELBOW

BHBLM

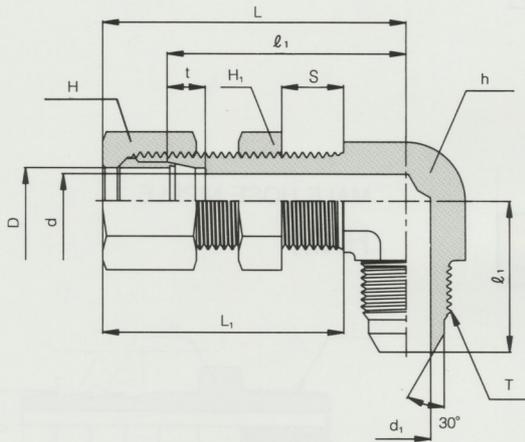

BITE TO FEMALE HOSE BULKHEAD ELBOW

BHBLF

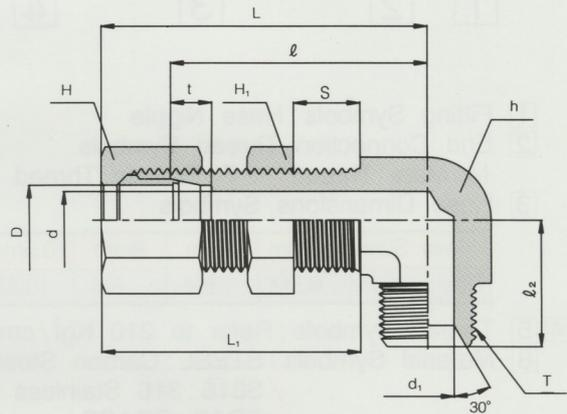

PART No.	Tube O · D	T G(PF)	d	d ₁	h	H ₁	H	t	l	l ₁	l ₂	Approx L ₁	Approx L	Panel Hole Drill size	Max Panel thickness S	
BHBLM08-02G	BHBLF08-02G	8	1/4	6	6	19	19	17	7	46	28	26	42.5	56.5	14.5	13
BHBLM08-03G	BHBLF08-03G	8	3/8	6	9	19	19	17	7	46	30	27	42.5	56.5	14.5	13
BHBLM10-02G	BHBLF10-02G	10	1/4	8	6	22	22	19	7	48	28	28	43.5	59.5	16.5	13
BHBLM10-03G	BHBLF10-03G	10	3/8	8	9	22	22	19	7	48	30	29	43.5	59.5	16.5	13
BHBLM10-04G	BHBLF10-04G	10	1/2	8	12	24	22	19	7	49	35	33	43.5	60.5	16.5	13
BHBLM12-02G	BHBLF12-02G	12	1/4	10	6	24	24	22	7	49	31	30	43.5	60.5	18.5	13
BHBLM12-03G	BHBLF12-03G	12	3/8	10	9	24	24	22	7	49	33	30	43.5	60.5	18.5	13
BHBLM12-04G	BHBLF12-04G	12	1/2	10	12	24	24	22	7	49	35	33	43.5	60.5	18.5	13
BHBLM15-03G	BHBLF15-03G	15	3/8	12	9	27	27	27	7.5	57	36	33	49.5	69.5	22.5	15
BHBLM15-04G	BHBLF15-04G	15	1/2	12	12	27	27	27	7.5	57	37	36	49.5	69.5	22.5	15
BHBLM16-03G	BHBLF16-03G	16	3/8	13	9	30	30	30	7.5	59	37	34	49.5	71.5	24.5	15
BHBLM16-04G	BHBLF16-04G	16	1/2	13	12	30	30	30	7.5	59	38	37	49.5	71.5	24.5	15
BHBLM18-04G	BHBLF18-04G	18	1/2	14	12	32	32	32	8	63	39	37	51.5	75.5	26.5	15
BHBLM20-06G	BHBLF20-06G	20	3/4	16	16	32	32	36	8	65	40	40	51.5	77.5	28.5	15
BHBLM22-04G	BHBLF22-04G	22	1/2	18	12	36	36	36	9	65	40	40	51.5	77.5	30.5	15
BHBLM22-06G	BHBLF22-06G	22	3/4	18	16	36	36	36	9	65	40	40	51.5	77.5	30.5	15
BHBLM25-06G	BHBLF25-06G	25	3/4	20	16	41	41	41	10	68	43	43	52.5	81.5	35.5	15
BHBLM25-08G	BHBLF25-08G	25	1	20	20	41	41	41	10	68	43	43	52.5	81.5	35.5	15
BHBLM28-06G	BHBLF28-06G	28	3/4	22	16	46	46	46	10	74	48	48	55	88	38.5	15
BHBLM28-08G	BHBLF28-08G	28	1	22	22	46	46	46	10	74	48	48	55	88	38.5	15
BHBLM30-06G	BHBLF30-06G	30	3/4	25	16	46	46	46	10	74	48	48	55.5	88.5	40.5	15
BHBLM30-08G	BHBLF30-08G	30	1	25	22	46	46	46	10	74	48	48	55.5	88.5	40.5	15

All dimensions are in millimeters. Dimensions are for reference only, subject to change.

Hydraulic Hose Fittings

■ PART NUMBER DESIGNATIONS

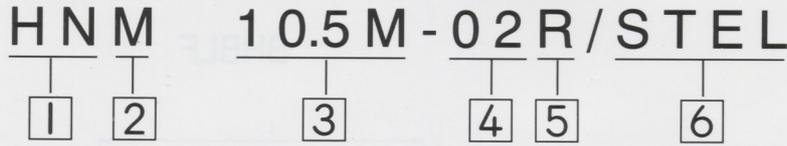

- ① Fitting Symbols : Hose Nipple
- ② End Connection Thread Symbols
M : Male Thread F : Female Thread
- ③ Hose Dimensions Symbols

Hose Size	6.5mm	8mm	9mm	10.5mm	12.7mm
Designation	6.5M	8M	9M	10.5M	12.7M

- ④ ⑤ Thread Symbols : Refer to 210 Kg/cm²
- ⑥ Material Symbols : STEEL : Carbon Steel
S316 : 316 Stainless steel
BRAS : BRASS

MALE HOSE NIPPLE

HNM

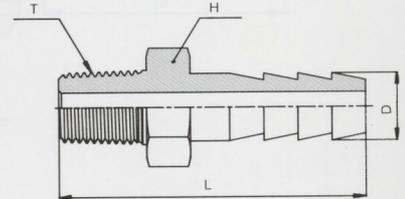

FEMALE HOSE NIPPLE

HNF

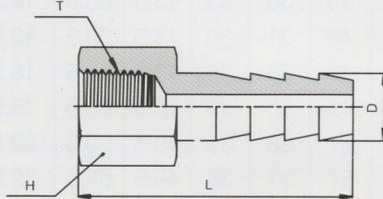

PART No.	D	T R(PT)	H	L
HNF 8M - 02R	8	1/4	19	39
HNF 8M - 03R	8	3/8	22	41
HNF 9M - 02R	9	1/4	19	41
HNF 9M - 03R	9	3/8	22	41
HNF10.5M - 02R	10.5	1/4	19	44
HNF10.5M - 03R	10.5	3/8	22	47
HNF10.5M - 04R	10.5	1/2	27	51
HNF12.7M - 02R	12.7	1/4	19	45
HNF12.7M - 03R	12.7	3/8	22	48
HNF 14M - 04R	14	1/2	27	52

PART No.	D	T R(PT)	H	L
HNM 6.5M-01R	6.5	1/8	12	33
HNM 6.5M-02R	6.5	1/4	14	37
HNM 6.5M-03R	6.5	3/8	17	39
HNM 8M-01R	8	1/8	12	36
HNM 8M-02R	8	1/4	14	40
HNM 8M-03R	8	3/8	17	42
HNM 9M-02R	9	1/4	14	42
HNM 9M-03R	9	3/8	17	43
HNM10.5M-01R	10.5	1/8	12	40
HNM10.5M-02R	10.5	1/4	14	45
HNM10.5M-03R	10.5	3/8	17	46
HNM10.5M-04R	10.5	1/2	22	51
HNM12.7M-02R	12.7	1/4	14	46
HNM12.7M-03R	12.7	3/8	17	48
HNM12.7M-04R	12.7	1/2	22	52
HNM 14M-02R	14	1/4	17	47
HNM 14M-03R	14	3/8	17	48
HNM 14M-04R	14	1/2	22	52
HNM 16M-04R	16	1/2	22	52
HNM 16M-06R	16	3/4	27	54
HNM20.5M-04R	20.5	1/2	22	59
HNM20.5M-06R	20.5	3/4	27	61
HNM20.5M-08R	20.5	1	36	65
HNM 27M-06R	27	3/4	30	67
HNM 27M-08R	27	1	36	71
HNM 34M-08R	34	1	36	86
HNM 34M-10R	34	1-1/4	46	88
HNM 38M-10R	38	1-1/4	46	89
HNM 40M-12R	40	1-1/2	50	92
HNM 52M-16R	52	2	65	120

All dimensions are in millimeters. Dimensions are for reference only, subject to change.

Standard Thread Specification

SAE / MS INTERNAL STRAIGHT THREAD BOSS

O - RINGS FOR SAE BOSSES

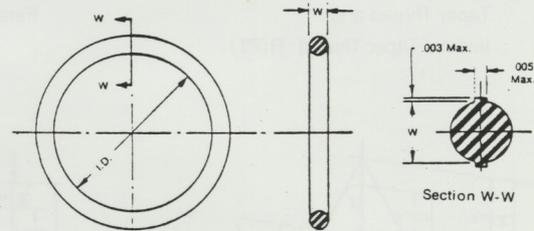
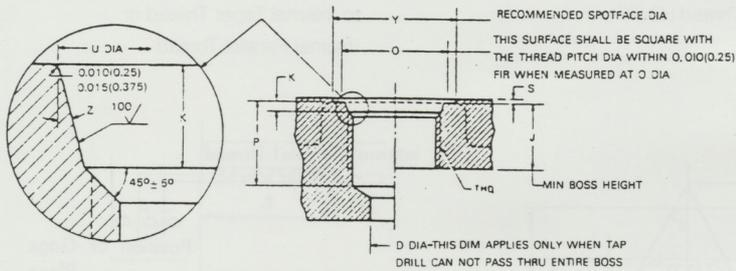

Port Size	Thread Size	D Min.	J Min.	K $+0.4$ -0	O Min.	P Min.	U $+0.13$ -0	Y	S Max.	Z ($\pm 1^\circ$)	O-ring Dimensions	
											ID	W
04	7/16-20	4.4	11.5	2.4	15	14.0	12.4	21	1.6	12°	.351	.072
05	1/2-20	6.0	11.5	2.4	16	14.0	14.0	23	1.6	12°	.414	.072
06	9/16-18	7.5	12.7	2.5	18	15.5	15.6	25	1.6	12°	.468	.078
08	3/4-16	10.0	14.3	2.5	22	17.5	20.6	30	2.4	15°	.644	.087
10	7/8-14	12.5	16.7	2.5	26	20.5	23.9	34	2.4	15°	.755	.097
12	1-1/16-12	16.0	19.0	3.3	32	23.0	29.2	41	2.4	15°	.924	.116
14	1-3/16-12	18.0	19.0	3.3	35	23.0	32.3	45	2.4	15°	1.048	.116
16	1-5/16-12	21.0	19.0	3.3	38	23.0	35.5	49	3.2	15°	1.171	.116

INTERNAL STRAIGHT PIPE THREAD BOSS

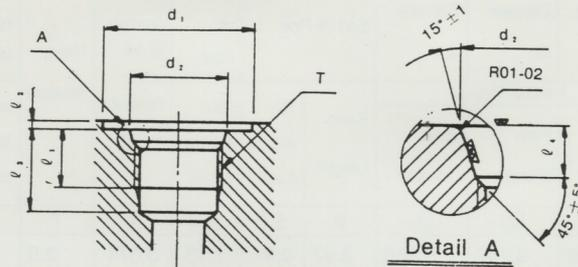

T G(PF)	d ₁	d ₂ $+0.1$ -0	Min l ₁	Max l ₂	Min l ₃	l ₄ $+0.4$ -0	O-Ring Spec.
1/8	18	11.6	10	1	15	2	P 8
1/4	24	15.6	14	1.5	20	2.5	P 11
3/8	28	18.6	14	2	20	2.5	P 14
1/2	34	22.6	17	2.5	25	2.5	P 18
3/4	45	29.8	19	2.5	27	3.5	P 24
1	51	35.8	22	2.5	31	3.5	P 29
1-1/4	62	44.8	24	2.5	33	3.5	P 38
1-1/2	68	50.8	25	2.5	34	3.5	P 44
2	76	67.2	29	2.5	38	3.5	P 56

All dimensions are in millimeters. Dimensions are for reference only, subject to change.

Standard Thread Specification

TAPER PIPE THREADS(JIS B0203 / B0202)

Basic profile of External
Taper Thread and
Internal Taper Thread : R(PT)

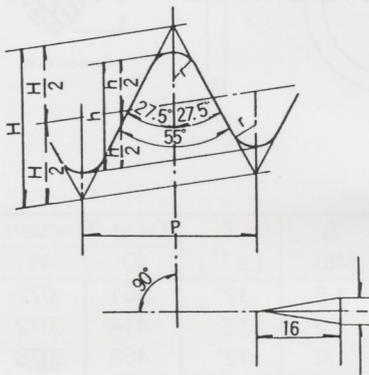

$$P = 25.4 / n$$

$$H = 0.960237 P$$

$$h = 0.640329 P$$

$$r = 0.137278 P$$

Basic profile of Internal
Parallel Thread : G(PF)

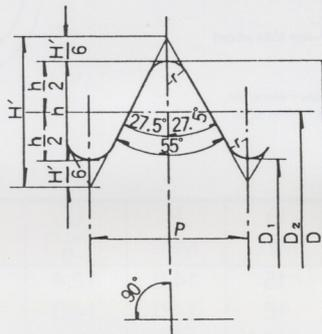

$$P = 25.4 / n$$

$$H' = 0.969491 P$$

$$h' = 0.640327 P$$

$$r' = 0.137329 P$$

Fit of External Taper Thread
to Internal Taper Thread or
Internal Parallel Thread

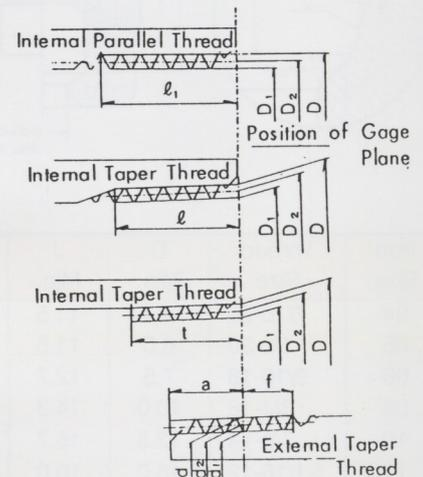

Unit : mm

Nominal Size	Screw Thread				Basic Diameter			Position of Basic Diameter			Tol- erances on Basic Di- ameters of In- ternal Parallel Thread	Effective Thread Length (Min.)				Nominal Pipe Size (For Reference)	
	Number of Thread per Inch	Pitch	Height of Thread	Rounding	External Thread			External Thread				Fitting	Internal Thread				
					Major Diameter d	Major Diameter d ₂	Major Diameter d ₁	From the End of Pipe					When there is an Incomplete thread of More	When there is an In- complete Thread			
					Internal Thread			Basic Length a	Tol- erance Axially ±b	Tol- erance Axially ±c					Allowance		
Major Diameter	Pitch Diameter	Minor Diameter	±	±	±	f	l				l ₁	t	Outside Diameter	Wall thick- ness			
R(PT) 1/8	28	0.9071	0.581	0.12	9.728	9.147	8.566	3.97	0.91	1.13	0.071	2.5	6.2	7.4	4.4	10.5	2.0
R(PT) 1/4	19	1.3368	0.856	0.18	13.157	12.301	11.445	6.01	1.34	1.67	0.104	3.7	9.4	11.0	6.7	13.8	2.3
R(PT) 3/8	19	1.3368	0.856	0.18	16.662	15.806	14.950	6.35	1.34	1.67	0.104	3.7	9.7	11.4	7.0	17.3	2.3
R(PT) 1/2	14	1.8143	1.162	0.25	20.955	19.793	18.631	8.16	1.81	2.27	0.142	5.0	12.7	15.0	9.1	21.7	2.8
R(PT) 3/4	14	1.8143	1.162	0.25	26.441	25.279	24.117	9.53	1.81	2.27	0.142	5.0	14.1	16.3	10.2	27.2	2.8
R(PT) 1	11	2.3091	1.479	0.32	33.249	31.770	30.291	10.39	2.31	2.89	0.181	6.4	16.2	19.1	11.6	34.0	3.2
R(PT) 1 1/4	11	2.3091	1.479	0.32	41.910	40.431	38.952	12.70	2.31	2.89	0.181	6.4	18.5	21.4	13.4	42.7	3.5
R(PT) 1 1/2	11	2.3091	1.479	0.32	47.803	46.324	44.845	12.70	2.31	2.89	0.181	6.4	18.5	21.4	13.4	48.6	3.5
R(PT) 2	11	2.3091	1.479	0.32	59.614	58.135	56.656	15.88	2.31	2.89	0.181	7.5	22.8	25.7	16.9	60.5	3.8
R(PT) 2 1/2	11	2.3091	1.479	0.32	75.184	73.705	72.226	17.46	3.46	3.46	0.216	9.2	26.7	30.1	18.6	76.3	4.2
R(PT) 3	11	2.3091	1.479	0.32	87.884	86.405	84.926	20.64	3.46	3.46	0.216	9.2	29.8	33.3	21.1	89.1	4.2
R(PT) 3 1/2	11	2.3091	1.479	0.32	100.330	98.851	97.372	22.23	3.46	3.46	0.216	9.2	31.4	34.9	22.4	101.6	4.2
R(PT) 4	11	2.3091	1.479	0.32	113.030	111.551	110.072	25.40	3.46	3.46	0.216	10.4	35.8	39.3	25.9	114.3	4.5
R(PT) 5	11	2.3091	1.479	0.32	138.430	136.951	135.472	28.58	3.46	3.46	0.216	11.5	40.1	43.5	29.3	139.8	4.5
R(PT) 6	11	2.3091	1.479	0.32	163.830	162.351	160.872	28.58	3.46	3.46	0.216	11.5	40.1	43.5	29.4	165.2	5.0

Standard Thread Specification

AMERICAN NATIONAL STANDARD TAPER PIPE THREADS : NPT(ANSI : B1.20.1)

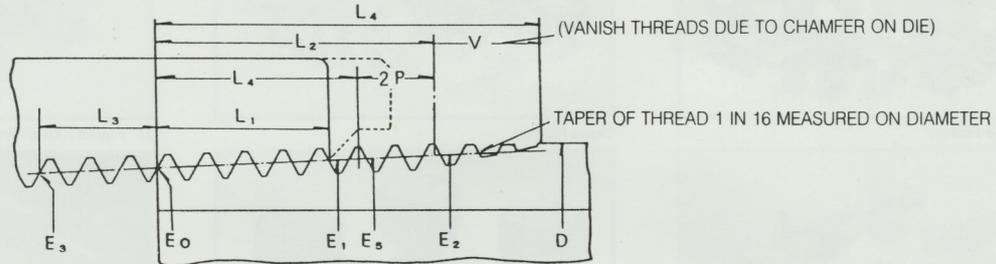

Unit : Inch

Nominal Pipe Size	Wrench Make - up Length for External Thread $L_2 - L_1$	Wrench Make - up Length for Internal Thread		Vanish Thread, V (3.47 Thds)	Overall Length External Thread L_4	Nominal Perfect External Threads		Height of Thread h	Basic Minor Diam. at Small End of Pipe K_0
		Length L_3	Dia E_3			Length L_5	Dia E_5		
1/16	0.1011	0.1111	0.26424	0.1285	0.3896	0.1870	0.28287	0.02963	0.2416
1/8	0.1024	0.1111	0.35656	0.1285	0.3924	0.1898	0.37537	0.02963	0.3339
1/4	0.1740	0.1667	0.46697	0.1928	0.5946	0.2907	0.49556	0.04444	0.4329
3/8	0.1678	0.1667	0.60160	0.1928	0.6006	0.2967	0.63056	0.04444	0.5676
1/2	0.2137	0.2143	0.74504	0.2478	0.7815	0.3909	0.78286	0.05714	0.7013
3/4	0.2067	0.2143	0.95429	0.2478	0.7935	0.4029	0.99286	0.05714	0.9105
1	0.2828	0.2609	1.19733	0.3017	0.9845	0.5089	1.24543	0.06957	1.1441
1 1/4	0.2868	0.2609	1.54083	0.3017	1.0085	0.5329	1.59043	0.06957	1.4876
1 1/2	0.3035	0.2609	1.77978	0.3017	1.0252	0.5496	1.83043	0.06957	1.7265
2	0.3205	0.2609	2.25272	0.3017	1.0582	0.5826	2.30543	0.06957	2.1995
2 1/2	0.4555	0.2500	2.70391	0.4337	1.5712	0.8875	2.77500	0.10000	2.6195
3	0.4340	0.2500	3.32500	0.4337	1.6337	0.9500	3.40000	0.10000	3.2406
3 1/2	0.4290	0.2500	3.82188	0.4337	1.6837	1.0000	3.90000	0.10000	3.7375
4	0.4560	0.2500	4.31875	0.4337	1.7337	1.0500	4.40000	0.10000	4.2344
5	0.4693	0.2500	5.37511	0.4337	1.8400	1.1563	5.46300	0.10000	5.2907
6	0.5545	0.2500	6.43047	0.4337	1.9462	1.2625	6.52500	0.10000	6.3461

Nominal	Outside Diam. of Pipe D	Threads per Inch n	Pitch of Thread P	Pitch Diameter at Beginning of External Thread E_0	Handtight Engagement		Effective Thread External	
					Length L_1	Diam E_1	Length L_2	Diam E_2
1/16	0.3125	27	0.03704	0.27118	0.160	0.28118	0.2611	0.28750
1/8	0.405	27	0.03704	0.36351	0.1615	0.37360	0.2639	0.38000
1/4	0.540	18	0.05556	0.47739	0.2278	0.49163	0.4018	0.50250
3/8	0.675	18	0.05556	0.61201	0.240	0.62701	0.4078	0.63750
1/2	0.840	14	0.07143	0.75843	0.320	0.77843	0.5337	0.79179
3/4	1.050	14	0.07143	0.96768	0.339	0.98887	0.5457	1.00179
1	1.315	11 1/2	0.08696	1.21363	0.400	1.23863	0.6828	1.25630
1 1/4	1.660	11 1/2	0.08696	1.55713	0.420	1.58338	0.7068	1.60130
1 1/2	1.900	11 1/2	0.08696	1.79609	0.420	1.82234	0.7235	1.84130
2	2.375	11 1/2	0.08696	2.26902	0.436	2.29627	0.7565	2.31630
2 1/2	2.875	8	0.12500	2.71953	0.682	2.76216	1.1375	2.79062
3	3.500	8	0.12500	3.34062	0.766	3.38850	1.2000	3.41562
3 1/2	4.000	8	0.12500	3.83750	0.821	3.88881	1.2500	3.91562
4	4.500	8	0.12500	4.33438	0.844	4.38712	1.3000	4.41562
5	5.563	8	0.12500	5.39073	0.937	5.44929	1.4063	5.47862
6	6.625	8	0.12500	6.44609	0.958	6.50597	1.5125	6.54062