

Specifications

For other materials or modifications, please consult TESCO. M.

OPERATING PARAMETERS

Pressure rating per criteria of ANSI/ASME B31.3

Maximum Inlet Pressure

400 and 3500 psig / 27.6 and 241 bar

Outlet Pressure Range

1-25, 1-50, 2-100, 2-250, 5-500, 5-600 psig
0.07-1.7, 0.07-3.4, 0.14-6.9, 0.14-17.2, 0.35-34.5, 0.35-41.4 bar

Design Proof Pressure

150% maximum rated

Operating Temperature¹

-15°F to 200°F / -26°C to 93°C

Flow Capacity

$C_v = 0.06$

$C_v = 0.15$

Maximum Operating Torque

30 in-lbs / 3.4 N•m

MEDIA CONTACT MATERIALS

Body

316 Stainless Steel or Brass

Bonnet

300 Series Stainless Steel or Brass

Piston

316 Stainless Steel or Brass

Seats

Polyimide (Vespel®)

O-Ring

FKM (Viton®-A)

Filter (40 micron)

316 Stainless Steel

Remaining Parts

300 Series Stainless Steel and Brass

OTHER

Cleaning

CGA 4.1 and ASTM G93

Connections

1/4" NPTF Inlet, Outlet and Gauge Ports

Weight (without gauges)

2 lbs / 0.9 kg

¹For extended temperatures from -40°F to 400°F / -40°C to 204°C, consult TESCO. M.

Vespel® and Viton® are registered trademarks of E.I du Pont de Nemours and Company.



TESCOM 44-5200 Series is a compact piston sensed pressure reducing regulator designed for heavy cycle duty applications. Venting or air load is optional for use with the TESCO. M. ER5000 Electropneumatic Controller.

Applications

- Test equipment
- Calibration stands
- Production equipment

Features and Benefits

- Compact and economical design
- For gas or liquid service
- Piston sensed for high reliability and long service life
- Standard version includes 1/4" NPTF gauge ports
- Brass or Stainless Steel construction
- Adjustable stop limits maximum outlet pressure
- Modification with 6000 psig / 414 bar inlet pressure is available
- Venting and captured venting is available
- NACE compliant designs are available

44-5200 SERIES

44-5200 Series Regulator Drawing

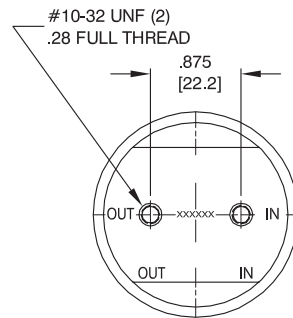
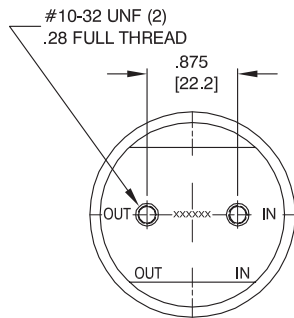
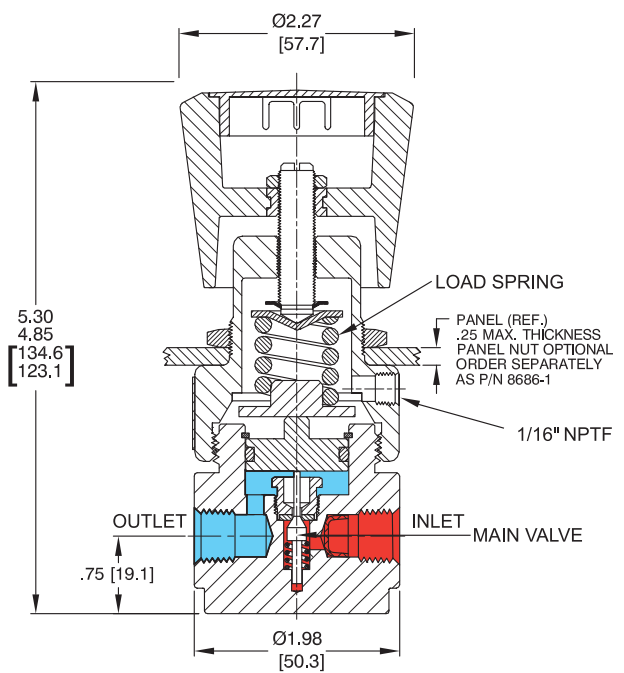
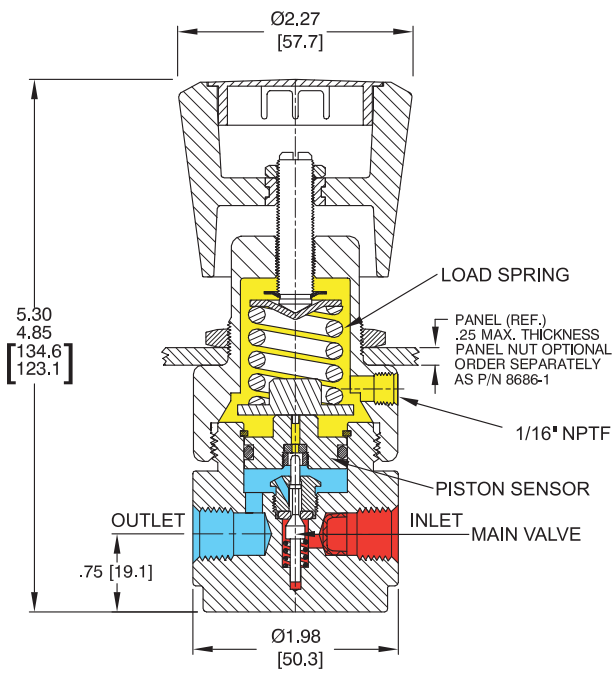
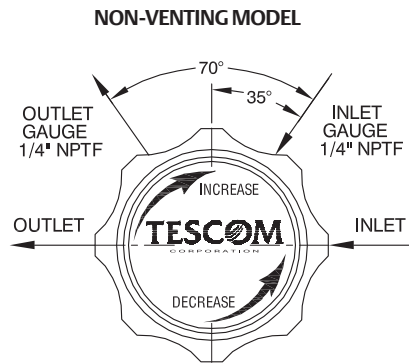
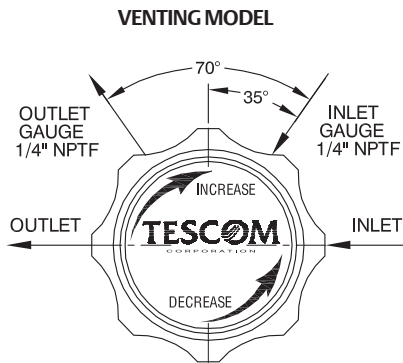

All dimensions are reference & nominal
Metric [millimeter] equivalents are in brackets

44-5200 Series Regulator Flow Charts

For more information on how to read flow curves, please refer to the Flow Curves and Calculations document (debul2007x012) in the TESCOM catalog or on www.tescom.com.

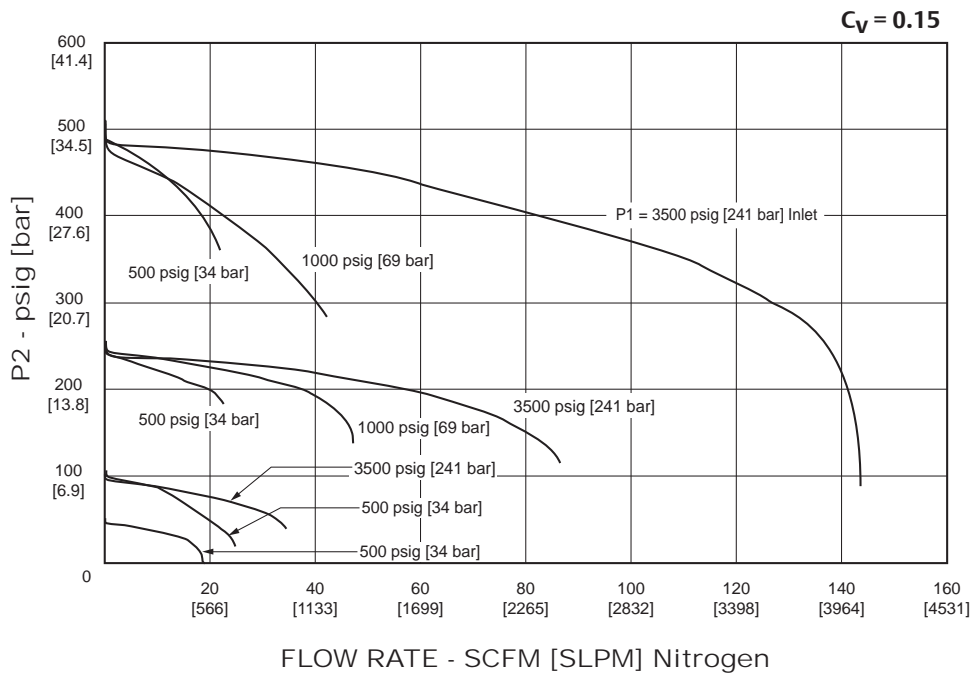
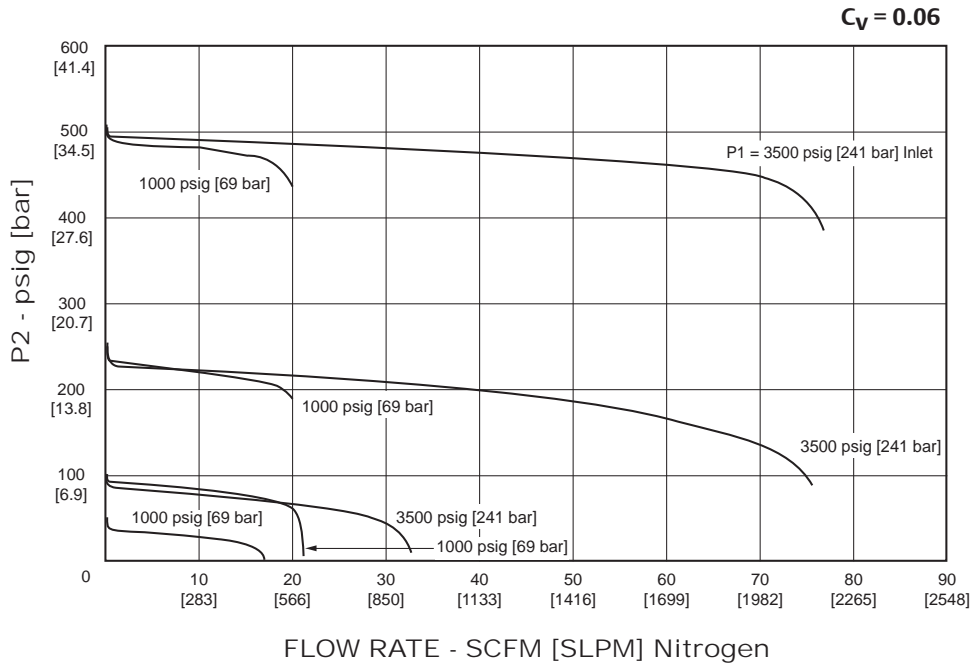

44-5200 SERIES

44-5200 Series Regulator Part Number Selector

Example for selecting a part number:

44-52 1 5 - 2 4 3 V - See Number Below

BASIC SERIES	BODY MATERIAL	OUTLET PRESSURE	INLET AND OUTLET PORT TYPE	PORT SIZE	INLET PRESSURE	FLOW CAPACITY	OPTIONAL VENTING	MODS
44-52	1 – Brass 6 – 316 Stainless Steel	0 – 1-25 psig 0.07-1.7 bar 1 – 1-50 psig 0.07-3.4 bar 2 – 2-100 psig 0.14-6.9 bar 3 – 2-250 psig 0.14-17.2 bar 5 – 5-500 psig 0.35-34.5 bar 6 – 5-600 psig 0.35-41.4 bar	2 – NPTF	4 – 1/4"	1 – 3500 psig 241 bar 2 – 400 psig 27.6 bar 3 – 3500 psig 241 bar	$C_V = 0.06$ $C_V = 0.15$ $C_V = 0.15$	V – Venting	-038 – Dome loaded -VA027 – Air loaded, Venting* * Mod VA027 is only available for outlet pressure 5 -500 psig / 0.35 - 34.5 bar