

Specifications

For other materials or modifications, please consult TESCO M.

OPERATING PARAMETERS

Pressure rating per criteria of ANSI/ASME B31.3

Maximum Inlet Pressure

300, 600, 1000, or 3500 psig / 20.7, 41.4, 69.0, or 241 bar

Outlet Pressure Ranges

100 mm Hg absolute - 15 psig, 3-30, 3-60, 4-100, and 4-150 psig
100 mm Hg absolute - 1.0 bar, 0.21-2.1, 0.21-4.1, 0.28-6.9,
and 0.28-10.3 bar

Design Proof Pressure

150% of rated pressure

Design Burst Pressure

400% of rated pressure

Certified Maximum Inboard Leak Rate

$<1 \times 10^{-9}$ atm cc/sec He per ASTM E449

Operating Temperature:

Vespe l® Seat: -40°F to 300°F / -40°C to 149°C

PCTFE Seat: -40°F to 140°F / -40°C to 60°C

Teflon® PFA Seat: -40°F to 160°F / -40°C to 71°C

Flow Capacity

$C_v = 0.5$

MEDIA CONTACT MATERIALS

Body

316L VAR Stainless Steel with Electropolish

Diaphragm

Nickel Alloy (Hastelloy®)

Stem, Seal and Remaining Parts

316 Stainless Steel

Valve Seat

3500 psig / 241 bar: Polyimide (Vespe l®)

300 and 1000 psig / 20.7 and 69.0 bar: PCTFE

600 psig / 41.4 bar: PTFE PFA

OTHER

Internal Surface Finish

10 R_a microinch / 0.25 micrometer

Connections

Welded female or male VCR®

Tube stubs

High Purity Internal Connections (H.P.I.C.)

(Internal style of VCR®, compatible with male swivel VCR®)

Cleaning

DI water electronic grade cleaned

Internal Volume

14 cc with 1/2" VCR®

Weight

3.2 lbs / 1.5 kg

Vespe l® and Teflon® are registered trademarks of E.I. du Pont de Nemours and Company.

VCR® is a registered trademark of Cajon Co.

Hastelloy® is a registered trademark of Haynes International, Inc.



TESCOM 74-3000 Series ultra high purity pressure reducing regulator offers 5 R_a or 10 R_a surface finishes, high flow $C_v = 0.5$ and an internally threadless and low internal volume design. Inlet pressures are 600, 1000, or 3500 psig / 41.3, 69, or 241 bar with outlet pressures up to 150 psig / 10.3 bar.

Applications

- High flow purging systems
- 1/2" point-of-use
- Regulation of specialty gases
- Semiconductor manufacturing

Features and Benefits

- Compact, hand-loaded and pressure reducing
- Low internal volume
- Smooth unobstructed flow path for complete purging
- Internally threadless
- Absolute pressure range model is available
- Excellent leak integrity is created by metal-to-metal diaphragm to body seal

NOTE:

When choosing a regulator and control pressure, decaying inlet characteristic must be considered when the supply pressure is expected to change. The decaying inlet characteristic of a pressure reducing regulator is commonly known as the increase in control pressure due to the decrease in supply pressure. It is important to make sure this effect does not cause the control pressure to exceed the pressure rating of the unit's outlet or that of the downstream system.

For more information on decaying inlet, please refer to the Technical Information section of the product catalog and/or contact the TESCO M customer support further assistance.

74-3000 SERIES

74-3000 Series Regulator Drawing

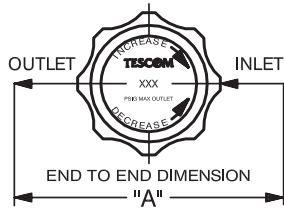

Figure A (no gauges)

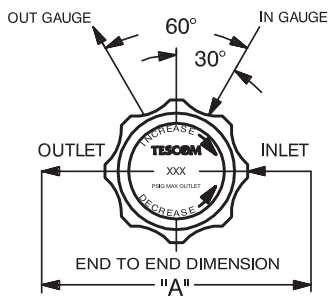

Figure B (2 gauges)

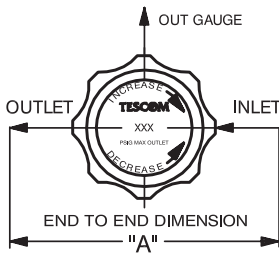

Figure C (1 gauge)

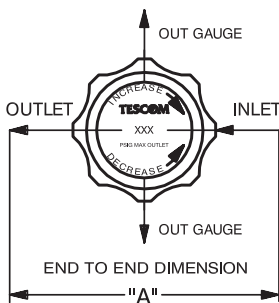
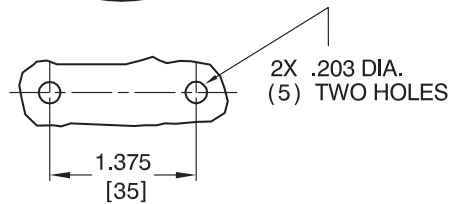
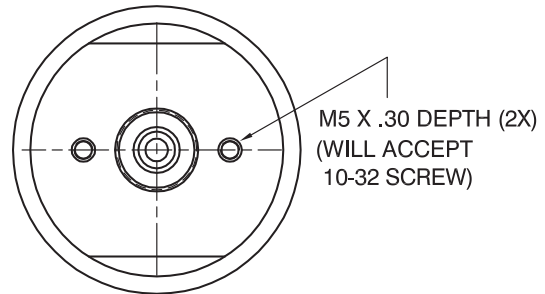
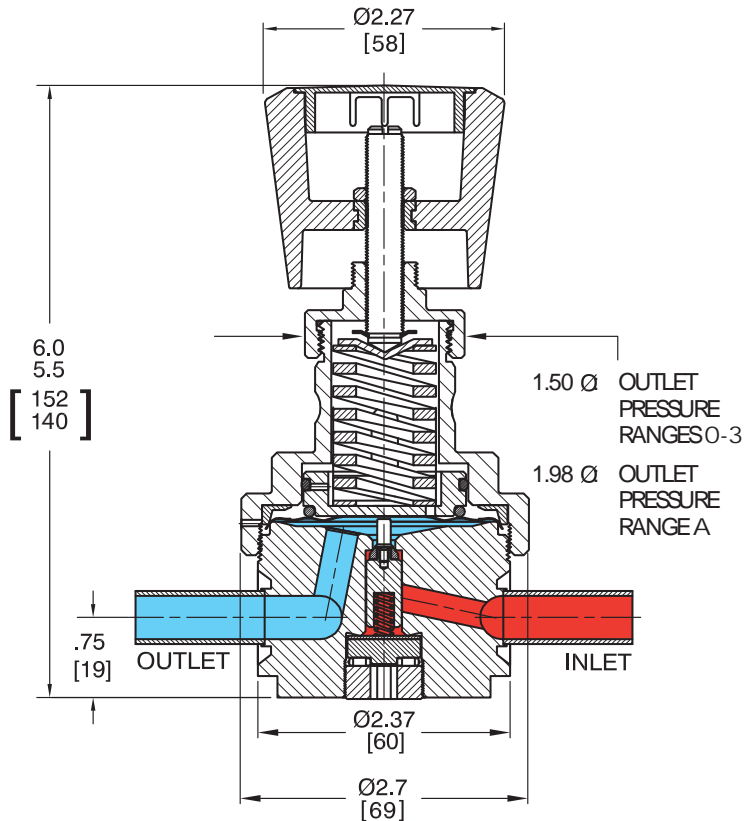

Figure D (2 gauges)



PANEL CUT OUT

All dimensions are reference & nominal
Metric [millimeter] equivalents are in brackets

74-3000 Series Regulator Flow Chart

For more information on how to read flow curves, please refer to the Flow Curves and Calculations document (debul2007x012) in the TESCOM catalog or on www.tescom.com.

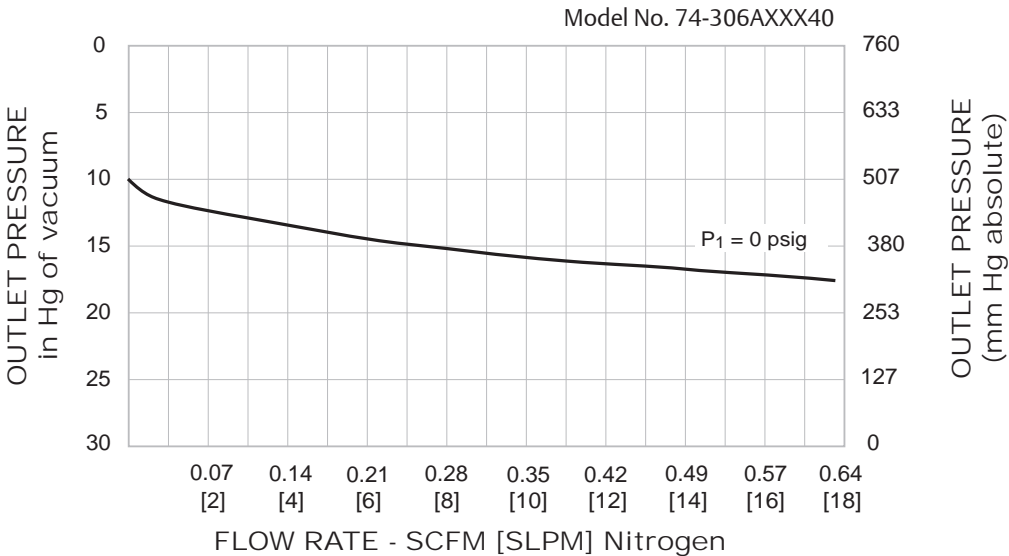
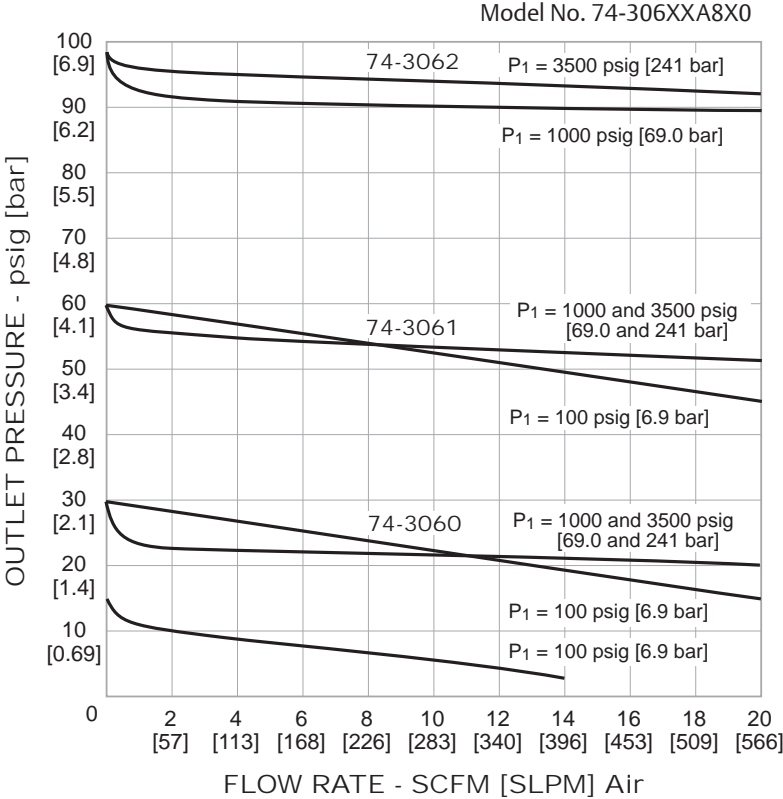

74-3000 SERIES

74-3000 Series Regulator Part Number Selector

Repair Kits, Accessories & Modifications may be available for this product. Please contact TESCOM for more information.

Example for selecting a part number:

74-30	6	2	K	T6	2	0			
BASIC SERIES	BODY MATERIAL	FINISH	OUTLET PRESSURE RANGES	SEAT MATERIAL	INLET AND OUTLET PORT TYPE AND SIZE	'A' ± .06"	MAXIMUM INLET PRESSURE	GAUGE PORT OPTION	NO. OF GAUGE PORTS (SEE FIGURE)
74-30	6 – 316L VAR® Stainless Steel Electropolish ¹	10 R ₃	A – 100 mm Hg absolute - 15 psig 100 mm Hg absolute - 1.0 bar 0 – 3-30 psig 0.21-2.1 bar 1 – 3-60 psig 0.21-4.1 bar 2 – 4-100 psig 0.28-6.9 bar 3 – 4-150 psig 0.28-10.3 bar	V – Polyimide (Vespel®) (3500 psig / 241 bar only) K – PCTFE (not available with 3500 psig / 241 bar inlet) T – PTFE PFA (600 psig / 41.4 bar only)	T4 – 1/4" Tube Stubs T6 – 3/8" Tube Stubs T8 – 1/2" Tube Stubs RA – 1/4" Male Fixed RU – 1/2" Male Swivel RW – 1/2" Female Swivel SV – IN Port:1/2" Male Swivel; OUT Port: 1/2" Female SZ – IN Port:1/2" Female; OUT Port: 1/2" Male Swivel	3.70 3.70 3.70 3.70 5.59 5.59 5.59 5.59	1 – 3500 psig 241 bar 2 – 1000 psig 69.0 bar 3 – 600 psig 41.4 bar 4 – 300 psig 20.7 bar (Absolute only)	0 – None 1 – 1/4" H.P.I.C. 2 – 1/4" H.P.I.C. 3 – 1/4" H.P.I.C. 4 – 1/4" Male Swivel 5 – 1/4" Male Swivel 6 – 1/4" Male Swivel 7 – 1/4" Female Swivel 8 – 1/4" Female Swivel 9 – 1/4" Female Swivel S – 1/4" Fixed Male T – 1/4" Fixed Male U – 1/4" Fixed Male	0 (Figure A) 1 (Figure C) 2 (Figure B) 2 (Figure D) 2 (Figure D) 1 (Figure C) 2 (Figure B) 2 (Figure B) 1 (Figure C) 2 (Figure B) 2 (Figure B) 1 (Figure C) 2 (Figure B) 1 (Figure C) 2 (Figure D)
			1. Per SEMI F19, UHP grade						